

update to general catalogue

2009



"Noi siamo sul
promontorio **estremo**
dei secoli!... Perché
dovremmo guardarci
alle spalle, se vogliamo
sfondare le misteriose
porte dell'Impossibile?"

Filippo Tommaso Marinetti

Manifesto del Futurismo
Le Figaro
20 Febbraio 1909

"Noi creiamo ogni giorno
prodotti audio d'avanguardia
che ci collocano a buon diritto
all'apogeo del sound reinforcement Italiano
e, una volta all'ascolto
di un sistema **X-Treme**,
scoprirete che non è solo
il contenuto tecnologico
ad aver raggiunto un livello superiore,
ma anche le vostre emozioni".

X-Treme Audio Staff
20 Febbraio 2009





Passion

An organization with the word “*extreme*” in its name must have a special **passion** for top grade sound reinforcement systems in its own DNA. The X-Treme *vertical line arrays* are a further confirmation of this concept: due to their extraordinary efficiency, sound quality and sturdiness they are rightfully placed at the top levels globally in the professional audio sector. X-Treme control electronics are up to the same mark: its wellknown reliability, remote control, and today, thanks to the new *Digital Technology Series* amplifiers, its very light weight, are the true “*reasons why*” which make the company’s electronic devices so different from those of its competitors. The real potential of a professional sound reinforcement audio system can be recognized while listening. Here, the X-Treme systems show what is really essential: the way in which the electrical power is supplied ensures high performances, such as the linearity of the frequency response and phase coherence, in all the applications and in a manner which is perceivable by virtually any type of listener.

“X-Treme: the choice for a higher level”.



What makes today's music reproduction extraordinary is not only the composer's skill or the performer's stylistic perfection: an exciting and breathtaking listening experience is mostly thanks to the sound quality of the amplification system used. Such quality is often associated with the vague and elusive "fidelity" concept of the reproduced sound. However, X-Treme engineers and technicians believe that the sonic accuracy of an audio system is closely related to the levels of **innovation** and technology it contains. The DNA of an X-Treme sound reinforcement system can be recognized at first sight. Every single detail of a loudspeaker system is fitted into a homogeneous and harmonious design, the lines and volumes stylistically highlight the originality of the different elements and, finally, the practical flying systems overcome the difficulty of having to produce and suspend complex clusters of elements.

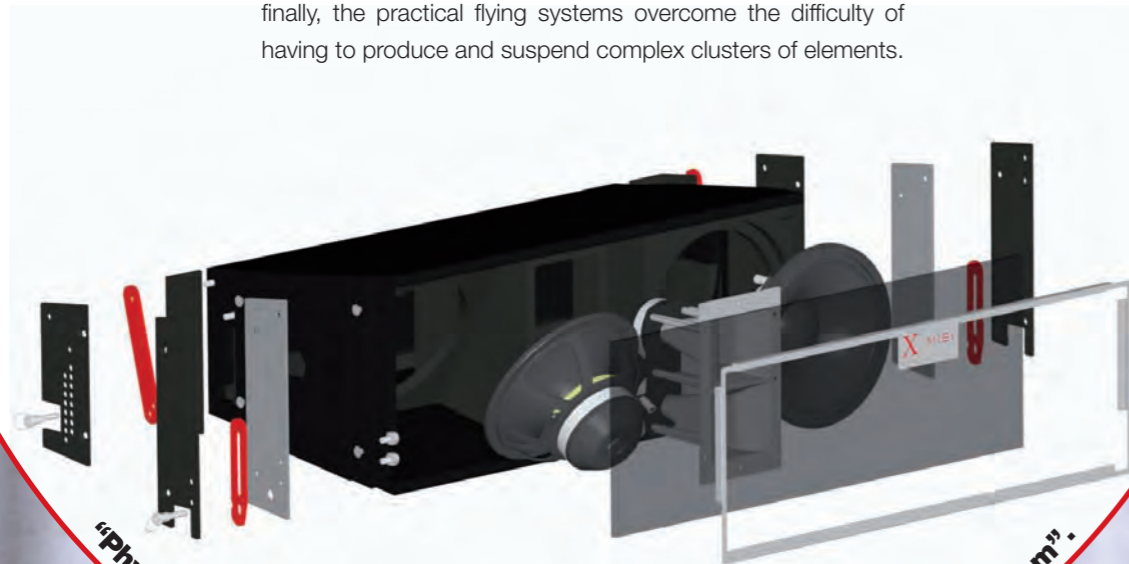

"Physical laws cannot be changed, but we can take advantages of them".



Innovation



Only by setting high standards can we achieve ambitious goals: this principle can also be applied to the PA systems. This is especially true for the X-Treme audio systems, which are highly valued by both professional listeners and users from all points of view. For performance levels (you just have to read the technical data about sensitivity, SPL peak, RMS power, etc...), sound **quality** (in terms of response linearity, phase coherence, clarity of reproduced sound, brightness, etc...), the captivating design (just think about the distinctive steel framework containing the sponge and crash-resistant grid), the components' undisputed reliability, the practical and ergonomic rigging system, and for countless other reasons. The most experienced users will appreciate that all the essential elements are clearly visible: the look is always attracted by the PA, the sound is always clear, uniform, coherent and pleasant.



“Another step to sound perfection”.

uality



Concert Sound



www.x-tremeaudio.com

Club Sound

peecker sound®

www.peeckersound.com

Commercial Sound

**XTE
electronic**

www.xteelectronic.com

Established in 2001, **X-Treme** represents the trademark of products manufactured by the *Strategic Business Unit* of the **Sound Corporation** group, which is specialized in the production of “concert, touring and portable sound systems”, i.e. professional audio systems designed for concerts, open-air musical entertainment or any other indoor venue where live music is performed.

Founded in 1968, the above mentioned group directly controls widely-recognized names such as **Peecker sound** (a leading company for over thirty years in the “fixed installations and club sound” sector, relying on an international distribution network, with more than a thousand sound reinforcement installations) and **XTE** (mainly referred to as the “commercial sound” sector, also known as “public address” in Italy).

The analysis, planning, development and control of customer retention programs are now combined with real “customer experience” initiatives (such as the recently established *X-Treme Partners*) to achieve one great goal:

*“a **Customer Centered Company**”.*



Passion

Innovation

Quality (TQM)

- **Technology**
- **Reliability and easy maintenance**
- **Ease of use**
- **After sales service**
- **Reputation**
- **Coherence**
- **Independence**



Modular And Robust Systems

Product "Bundle"

Usability

10-Year Warranty

High Quality Components

Competitive Prices

"Made in Italy"

1. HDSC™ (High Duty Speaker Cover)

All the cabinets of the X-Treme loudspeaker systems undergo a finish process aimed at creating a High Duty Speaker Cover (**HDSC™**). The working phases are as follows:

- carefully sanding the 15-mm thick Canadian birch cabinet equipped with suitable reinforcement cages;
- varnishing with a VFI-2513 structural plastic made up of two components (100% solid) for a hot coating (70° C) in hybrid expanded polyurethane. This varnishing complies with the stringent ASTM (*American Society for Testing Materials*) standards which guarantee excellent hardness, low porosity and high chemical resistance to weather conditions;
- applying five layers of resin and fiber glass glaze;
- finishing with a matt black, waterproof and scratch-resistant gel-coat.

This process, along with internal characteristics such as reinforcements and the use of slot-in elements, allows the production of a totally waterproof cabinet which is also "elastic", i.e. resistant to vibrations or similar mechanical stresses.

2. RODAP™ (RObust Design And Prototyping): from 'AS IS' to 'TO BE'.

The *Design Division*, in accordance with the methods and materials suggested by the *R&D Division*, defines the first draft "project specifications" which are the basic design requirements (*system design*). These project specifications must be approved by *General Management* before proceeding with the following phases of the project.

Robust Design and Prototyping phases

1) Design planning

The whole activity is planned through a PERT diagram, which defines the essential design phases and the strategic tasks assigned to each stage.

2) Design results

Then the actual design of the new product is carried out in *detail* (from the specifications to the design revision statement). The main design results are as follows: calculations regarding size, rough drawings (produced by using CAD hardware and software tools), part drawings and part coding in an experimental design statement.

3) Design checks

4) Prototype development

The first real operating design phase consists of creating several prototypes of the product being developed. The *New Product Division* often relies on the support of valued collaborators from the Technical Dept. and/or the Production Dept. upon request.

5) Design rechecks

6) Pre-series experimental checks

7) Project validation.

3. ESAH (Easy Suspending And Handling) systems

The X-Treme suspending systems have successfully passed the tensile, compressive, shear and combined bending stress resistance tests. Additionally, they have been certified as compliant with the **CNR UNI 10011** standard. These systems are made up of innovative design modular elements, which can be linked differently in order to suspend or stack the loudspeaker systems in a wide range of configurations. In particular, the handles of the vertical line array flying system have a new shape, which has improved their ergonomic design and handling. A new design of the martensitic steel pins (XT-PIN) has been developed to achieve a more resistant and stable profile, and consequently an easier and faster installation. The X-One line offers two different suspension options for the loudspeaker systems, while, in the upper and lower part of the cabinets, the new Deflector Line has been fitted with practical flying tracks that allow for a quick creation of suspended clusters, thanks to the special ring hook (XT-FTH).

4. X-MAXO™ (X-treme Maximum X-Over)

X-MAXO™ technology has allowed the X-Treme designers to make progress in the production of filters (*crossovers*) for both active and passive sound systems. In fact, the X-Treme filters feature a number of unique characteristics in this sector:

- They permit configuration changes of the loudspeaker system (from 2-way to 3-way or from full-range to bi-amp) by carrying out a simple operation on the high current handling terminals (*jumper*);
- They include an induction compensating network for mid to low ranges, and an equalization network for the tweeters,
- They also include an active protection device called HPCCR (*High Positive Current Coefficient Resistor*), which reduces the drastic clipping of the signal peaks due to an impedance fit for the loudspeaker's nominal input. The listening effect caused by this protection device is minimized by the Tungsten circuit delay. Moreover, the relevant mass warms up and cools down during transit in the RMS current,
- They are made up of "robust" components such as air coils, high insulation capacitors and armored resistors with aluminium heat sinks,
- They comply with the recently introduced ROHS regulations.

All this ensures highly efficient and reliable devices over time, in which phase rotation is minimized, with a perfect response to transients as a result.

5. EIWD™ (Electro-acoustic Isophase Wave Duct)

X-Treme engineers and designers have developed a new electro-acoustic transducer for mid-high frequencies made of an aluminium alloy treated with DSA (*Diamond blade cutting, Sanding and Anodizing*) surface processing technology. This device is called **EIWD™** and, together with its relevant drivers, ensures a very accurate control of the sound dispersion characteristics along different emission angles. Since the purpose of a line array system is to reduce sound emission in undesired directions and direct it towards the desired audience "sections", every single transducer has to direct the signals towards its own output "mouth" with perfectly controlled amplitudes and phases. After an accurate mapping of the sound waves near the output section has been carried out, the same algorithm has been used by X-Treme technicians to draw the three-dimensional development of the waveguide horn. By using the EIWD™ transducer, the final result is a far clearer sound reproduction, coherence and uniformity in the sound energy density distribution.

6. AWSH™ (Acoustic Wave Shaped Horn)

The **AWSH™** aluminium horn has been designed and built using CAE (*Computer Aided Engineering*) tools for a complete phase alignment of the acoustic wave guide with respect to the woofer; this occurs owing to the original geometric configuration of the nozzle and the ingenious prong that protrudes from the edge of the attachment, ensuring the physical and acoustic alignment of the unit to the front panel where the loudspeaker is located.

create your

SUCCESS

with

your experience

& our technology



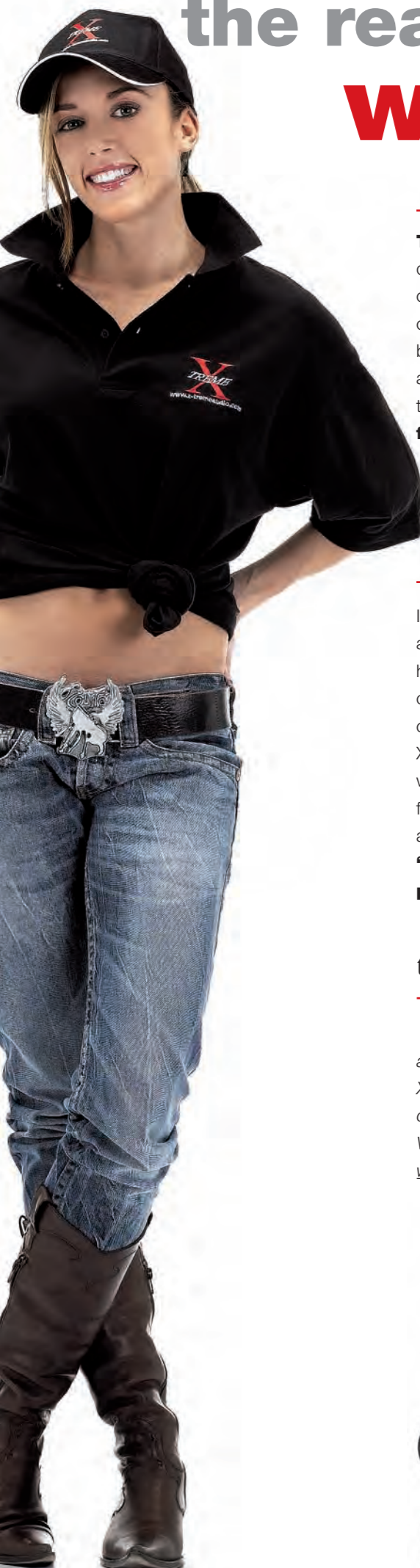

the reasons why...

TQM

TQM (Total Quality Management) was developed in Japan in the early '80s. It can be defined as a way of managing an organization which is focused on quality, based on the participation of all its members and aimed at achieving long-term success through the **"full satisfaction of the final customer"**.

PERSONAL SELLING & INTERNATIONAL DEALERS NETWORK

In order to promote its audio systems and to raise people awareness of their higher qualities compared to those of its competitors, the company essentially relies on the commitment of its own **distributors**. X-Treme provides useful services (*benefits*) which depend on the dealer/distributor's feedback (*duties*) with the purpose of achieving a higher level of partnership.

"Not everybody can sell X-Treme products!"

XT4U: the INTERACTIVE GUIDE

"Hi, my name is **XT4U (X-Treme for you)** and I'm the interactive sales assistant for X-Treme products, the "live sound" division of the Sound Corporation group.

Visit me at:

www.x-tremeaudio.com/products/xt4u"

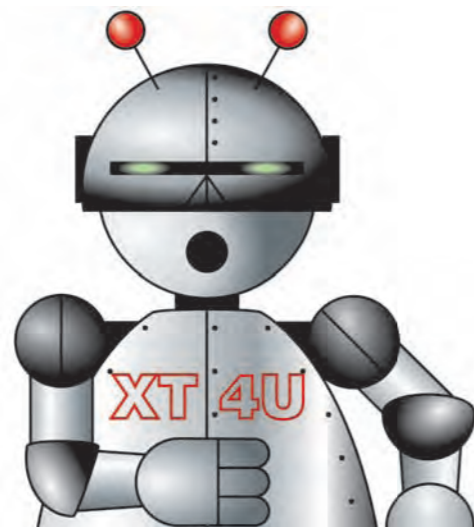

PROMOTION & MERCHANDISE

Every day X-Treme launches different **promotional initiatives** and offers a wide range of gadgets to reward the loyalty of its clientele and to boost Sales in its own business.

X-TREME PARTNERS

Within the various *customer experience* initiatives, a special mention goes to the creation of the **X-Treme Partners**, representative clients who have gone beyond the spot sale level by establishing a closer collaboration with more advantages.



AFTER SALES SERVICE

By purchasing an X-Treme product, you automatically choose an accurate and global assistance service. The network of **X-Treme Dealers** located in more than 20 countries all over the world and the **After Sales Service** in the headquarters of Reggio Emilia (Italy) guarantee a wide range of exclusive advantages and services to all clients. In fact, the state of a single unit can be checked at any time (simply by providing the serial number) or, if necessary, you can apply to the Assistance Centre for help.



they trusted us!



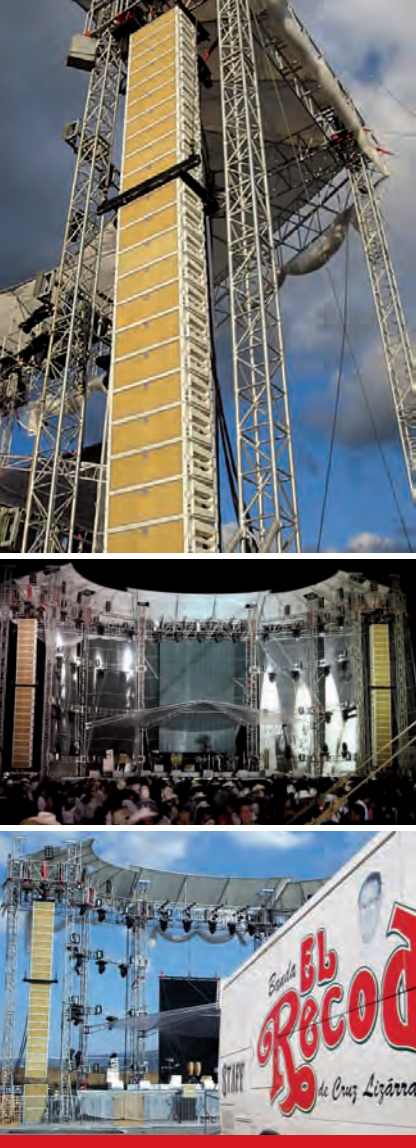

line arrays

Mini Line Array

loudspeaker systems

MISI™

loudspeaker systems

Linear Source Array

loudspeaker systems

targets

Audio distributors - Rental companies - Productions of musical events - Private/public corporations or institutions - Show agencies - Event promoters/organizers - Owners of public entertainment places - Portable PA users (*bands, musicians & entertainers*)

Audio distributors - Rental companies - Productions of musical events - Private/public corporations or institutions - Show agencies

Audio distributors - Rental companies - Productions of musical events - Private/public corporations or institutions

applications

Concert & touring
• small • medium • large scale

Arrayable FOH enclosures

Central clusters, front fill, side fill, delay towers, etc...

Open-air events,
public squares, etc...
• small • medium • large scale

Portable PA systems
for musicians, bands and entertainers
• small • medium size

Stadiums, Sports halls, Arenas

Theme parks, Circus shows

Theatres, Auditoriums, Music halls

Places of worship

Fixed installations
• small • medium • large size

Live clubs, Music pubs
and other Live Performance Venues
• small • medium • large size

Dance clubs, night clubs and lounge bars
• small • medium • large size

Multi-purpose venues,
Recreational and cultural structures,
Conference centers and Fairs

Cinemas

HO.RE.CA. (Hotel, Restaurant and Café)

Corporate A/V events

Festivals, Exhibitions, Competitions
and other public events

Concert & touring
• small • medium • large scale

Arrayable FOH enclosures

Central clusters, front fill, side fill, delay towers, etc...

Open-air events,
public squares, etc...
• small • medium • large scale

Portable PA systems
for musicians, bands and entertainers
• small • medium size

Stadiums, Sports halls, Arenas

Theme parks, Circus shows

Theatres, Auditoriums, Music halls

Places of worship

Fixed installations
• small • medium • large size

Live clubs, Music pubs
and other Live Performance Venues
• small • medium • large size

Dance clubs, night clubs and lounge bars
• small • medium • large size

Multi-purpose venues,
Recreational and cultural structures,
Conference centers and Fairs

Cinemas

HO.RE.CA. (Hotel, Restaurant and Café)

Corporate A/V events

Festivals, Exhibitions, Competitions
and other public events

Concert & touring
• small • medium • large scale

Arrayable FOH enclosures

Central clusters, front fill, side fill, delay towers, etc...

Open-air events,
public squares, etc...
• small • medium • large scale

Portable PA systems
for musicians, bands and entertainers
• small • medium size

Stadiums, Sports halls, Arenas

Theme parks, Circus shows

Theatres, Auditoriums, Music halls

Places of worship

Fixed installations
• small • medium • large size

Live clubs, Music pubs
and other Live Performance Venues
• small • medium • large size

Dance clubs, night clubs and lounge bars
• small • medium • large size

Multi-purpose venues,
Recreational and cultural structures,
Conference centers and Fairs

Cinemas

HO.RE.CA. (Hotel, Restaurant and Café)

Corporate A/V events

Festivals, Exhibitions, Competitions
and other public events



“to be clothed in... **fine array**”



HDSC™ - RODAP™

ESAH flying system

X-MAXO™ - EIWD™

HDSC™ - RODAP™

ESAH flying system

X-MAXO™ - EIWD™

HDSC™ - RODAP™

ESAH flying system

X-MAXO™

Linear Source Array

Loudspeaker systems

For high power sound reproduction, the use of several powerful speaker systems is required to reach the desired levels. The problem lies in the fact that, when combined together, many different sound sources interfere with each other ("combing"), creating peaks and distortions in the audience's ears. The underlying principle of **line array** systems is combining various elements along a sound line, an updated version of the *sound column*, which has been a well-known principle for a long time. The sound column provides a horizontal transmission with a very wide angle, while the vertical angle remains small. The typical problem is a destructive interference phenomenon occurring between different sources (directionality lobes). This problem has been solved thanks to the line array technology, also called an "orderly arrangement" of different speakers. As far as the horizontal arrays are concerned, the curved vertical arrays often provide a better solution in open spaces, large stadiums or arenas and in spaces with varying geometries, especially when more than one row of modules is necessary to cover the space from front to back. The design principle underlying the X-Treme vertical line arrays is "the same power on equivalent areas", rather than "a different power on equivalent angles", which occurs using traditional loudspeaker systems.



XTLSA

System configuration	3-way line array module
Power handling RMS	760 W
Frequency response	65+18k Hz (-3 dB)
Peak SPL (@1 m)	137 dB
Coverage angle (-6 dB)	120° horizontal
Nom. impedance (bi-amp)	8 (LF), 8 (MF+HF) Ohm
Nom. impedance (tri-amp)	8 (LF), 8 (MF), 8 (HF) Ohm
Transducers	LF 1x12" neodymium MF 2x6" neodymium HF 2x1" titanium
Input connectors	2 x NL8FC Speakon
Cabinet	birch plywood
Dimensions (WxHxD)	1044x392x550 mm
Net weight (Kg)	61



XTLSAS

System configuration	arrayable double sub.
Power handling RMS	2400 W
Frequency response	45+150 Hz (-3 dB)
Peak SPL (@1 m)	142 dB
Nominal impedance	4 Ohm
Transducers	2x18" neodymium
Input connectors	2 x NL8FC Speakon
Cabinet	birch plywood
Dimensions (WxHxD)	1044x470x800 mm
Net weight (Kg)	93,5
Special version	4+4 Ohm impedance



XTLSA/A

System configuration	active line array module
BI-Amplified RMS	800 + 800 W
	class D digital
Frequency response	65+18k Hz (-3 dB)
Peak SPL (@1 m)	137 dB
Coverage angle (-6 dB)	120° horizontal
Power supply	switching technology
	115 or 230 V ± 10%
Input	max +10 dBu - XLR
DSP on board	24 bit/96 kHz (2 preset)
PC network (XT-NET)	RJ45 plug - UTP Cat. 5 cable
Cabinet	birch plywood
Dimensions (WxHxD)	1044x392x550 mm
Net weight (Kg)	63



XTLSAS/A

System configuration	active arrayable double sub.
Amplifier RMS	2500 W - class D digital
Frequency response	45+150 Hz (-3 dB)
Peak SPL (@1 m)	142 dB
Power supply	switching technology
	115 or 230 V ± 10%
Input	max +10 dBu - XLR
DSP on board	24 bit/96 kHz (2 preset)
PC network (XT-NET)	RJ45 plug - UTP Cat. 5 cable
Cabinet	birch plywood
Dimensions (WxHxD)	1044x470x800 mm
Net weight (Kg)	95

Working principles

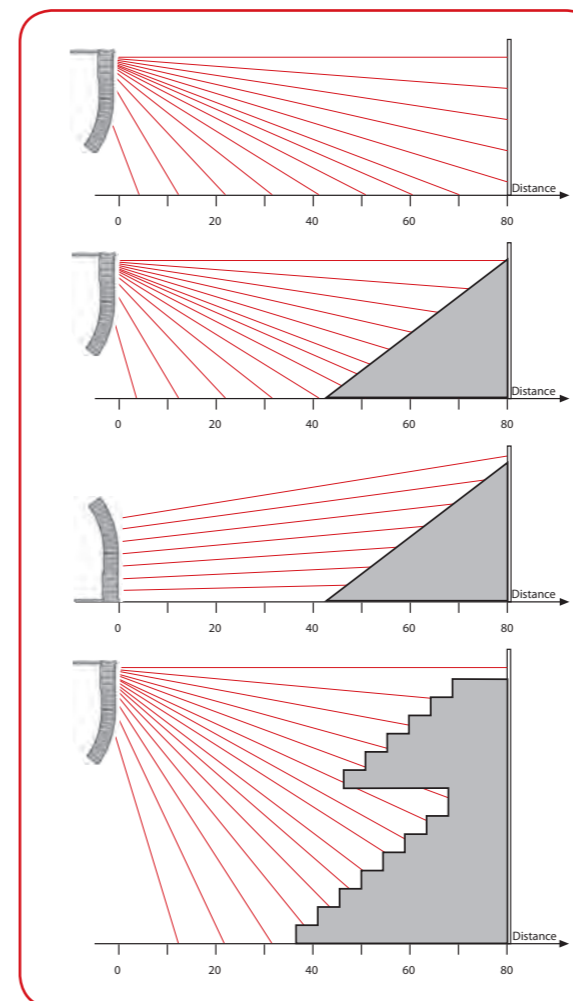

The **Linear Source Array** system has been designed by X-Treme's engineers to provide the highest sound performance for concerts, shows and other musical events held in large venues such as stadiums, arenas and so on. The **XTLSA** speaker is a three-way passive line array system made up of one 12" woofer, two 6" mid-range loudspeakers and two 1" neodymium drivers with a total power of 760 W RMS. XTLSA is a broad band system equipped with loading at low frequencies, which is unique in this category of products. It shows an amazing efficiency at high frequencies, an innovative concept and a horn loaded mid-range configuration and can be utilized without the subwoofer in several applications. If an extension is required on the subsonic frequencies, the XTLSA module can be integrated with a ground-aligned or flown-stacked **XTLSAS** unit, equipped with two high-powered 18" speakers with long range. Both models are fitted with the innovative certified ESAH flying system, which allows suspended line arrays to be installed quickly and safely. Because of the specially-designed handles, each unit can be hung easily, by using the **4 XT-PIN** which are supplied with each loudspeaker system, without using any other external device (*all included*).

Installation typologies

The *flying system* is the best solution for reaching a uniform sound pressure level if the ratio between the number of the suspended elements and the total area to be covered is sufficient to guarantee a suitable front to rear coverage. The flying system also allows common *sightline* problems to be easily solved, and provides better high frequency penetration into the audience area with a reduced *shadow* effect. In many cases, however, the system has to be stacked directly on-stage because of the type of space needing sound-reinforcement, or because it is impossible to suspend it. *Stacking* on stage offers more low frequency SPL due to enhanced floor coupling; additionally, for geometric reasons, a floor-stacked array can provide a higher vertical coverage than a flown one.



The flying system, for each single anchoring point, is sized for a maximum of **12 XTLSA** units



The stacking system is sized for a maximum of **8 XTLSA** units plus **4 XTLSAS** units.





Linear Source Array Loudspeaker systems



The main advantage of a *line array* configuration, as opposed to a traditional cluster, is the energy consumption savings arising from the narrowing of the vertical directivity and the increase in the directivity of the sources. These generate sound waves that attenuate only 3 dB for every doubling of distance (under "near field" conditions or "Fresnel area"), instead of 6 dB, which happens with traditional systems (*Inverse-square law*). These types of waves are known as *cylindrical* and they can be considered

as such only if they occur within a certain distance from the source, which depends on the frequency of the reproduced wave and on the source height (over great distances, in the *far-field*, all the real sound sources can be approximated through pulsating spheres known as monopoles). Since the cylindrical waves have only two dimensions of dispersion rather than three, as with the more common spherical waves, the sound attenuates much more gradually, depending on its distance from the source.



• The cone-shaped **components** are manufactured by leading world producers on the basis of the specifications provided by X-Treme engineers. All the loudspeakers are latest-generation devices (*above: the 6" midrange and the 12" woofer*): they feature an aluminium basket, cloth suspension, cellulose membrane (these two with NOMEX®) and a neodymium magnet.

• The certified **ESAH flying system**, thanks to its ergonomic handles housing all the flying devices, ensures a quick and safe anchoring of any suspended system and makes the speaker systems easy to handle. Moreover, the side wooden braces have been designed to be replaceable in case of wear and tear caused by usage and/or transport.

• All the Linear Source Array speakers can be supplied, on express request, with a **wheelboard**, which aids movement on the ground and is an excellent protective cover when positioned in front of the grid of the cabinet.



• The special **wave-guide horn** is coupled with state-of-the-art titanium compression drivers, and is able to irradiate flat waves whose wave fronts are in phase, i.e. without any destructive interference.

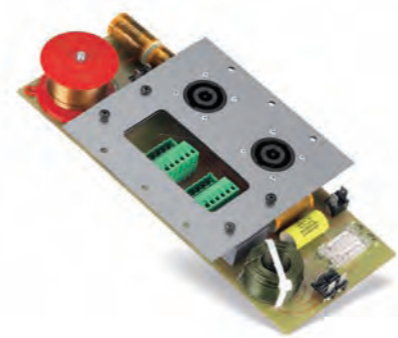

• The new passive **crossover filter** features **X-MAXO™** proprietary technology, through which the desired speaker system configuration (2-way or 3-way) can be selected by a simple switch of the high current handling terminals. The X-Treme filters have been designed to minimize all the phase reductions and distortions, are equipped with active protection devices fitted on the transducers and are made up of highly professional components such as air coils, high insulation capacitors and armored resistors with aluminium heat sinks.



on board AMPLIFIER

All the active (*self-powered*) versions of the X-Treme line array modules (**XTLSA/A**, **XTMISI/A** and **XTMLA/A**) have been configured in *bi-amplification*, thanks to a 800+800 W RMS *on board* amplifier with *switching* supply, which is state-of-the-art in the electronics for audio equipment sector, ensuring great power availability with extremely light weight. The active double subwoofers (**XTLSAS/A**, **XTMISIS/A** and **XTMLAS/A**) which, being part of the line array range, can be suspended (*arrayable*), offer a greater performance in terms of the RMS power supplied: they are powered by internal amplifiers made with the same technology, but which are able to supply power of up to 2500 W. Through the *switching* supply with an automatic voltage switching, these devices adapt to mains voltages ranging from 115 to 230 VAC. As in all X-Treme active loudspeaker systems,

the power of the amplifier is higher than the RMS power sustained by the transducers; therefore it is associated with suitable limiters to guarantee the highest dynamics in reproducing the most powerful signal peaks. The internal DSP with a 24 bit/96 kHz audio resolution, available on all models, provides for basic equalization and crossover : these features are pre-established and can be updated using files issued by X-Treme. Further interventions can be performed directly on each single panel of the amplifier (2 *presets* are available), while, thanks to PC interface software, full parametric equalization can be set, the *gain* and *speaker delay* can be managed, and a *noise gate* and *limiter* can be controlled; each active unit is characterized by an ID that allows its remote identification via the **XT-NET** connection network, thus permitting complete system control, even from a distance.

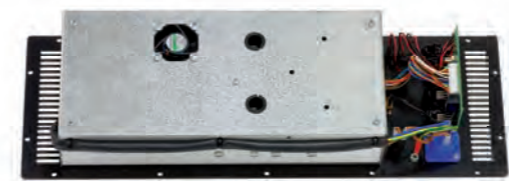

• All the internal **amplifiers** of the X-Treme line array elements are built with *switching* technology and can adjust themselves to the 2 most used mains voltages (115 or 230 VAC ± 10%). The inner DSP, 24 bit/96 kHz, can be remote controlled via the **XT-NET** connection network.



XTLSA/A

LSA accessories for SUSPENSION



STD-LSA
Flying bar for Linear Source Array

XT-ANGLE + XT-ANGLERC
See page. 29

LSA accessories

OTHERS



XT-NETINT
Network Interface for XT-NET connection (PC adapter: from USB or RS232 ports to standard RJ45 sockets)



XT-PSB32/8
Patch board 32A - 2 XLR IN, 2 XLR OUT - 4 Speakon OUT NL8MPR



XT-D8P
Connection panel specially designed for line arrays

XTLSA-SK
Wheelboard for XTLSA and XTLSA/A loudspeaker system

XTLSAS-SK
Wheelboard for XTLSAS and XTLSAS/A double subwoofer





MISI™

loudspeaker systems



XTMISI

System configuration	3-way line array module
Power handling RMS	900 W
Frequency response	50±18,5k Hz (-3 dB)
Peak SPL (@1 m)	136 dB
Coverage angle (-6 dB)	120° horizontal
Nom. impedance (bi-amp)	8 (LF), 8 (MF+HF) Ohm
Nom. impedance (tri-amp)	8 (LF), 8 (MF), 8 (HF) Ohm
Transducers	LF 1x10" neodymium MF 1x10" neodymium HF 2x1" titanium
Input connectors	2 x NL8FC Speakon
Cabinet	birch plywood
Dimensions (WxHxD)	820x320x410 mm
Net weight (Kg)	36

XTMISI/A



System configuration	active line array module
BI-Amplified RMS	800 + 800 W
	class D digital
Frequency response	50±18,5k Hz (-3 dB)
Peak SPL (@1 m)	136 dB
Coverage angle (-6 dB)	120° horizontal
Power supply	switching technology 115 or 230 V ± 10%
Input	max +10 dBu - XLR
DSP on board	24 bit/96 kHz (2 preset)
PC network (XT-NET)	RJ45 plug - UTP Cat. 5 cable
Cabinet	birch plywood
Dimensions (WxHxD)	820x320x410 mm
Net weight (Kg)	38

MISI™

The **MISI™ (Middle-Sized line array)** system contains all the know-how acquired by the X-Treme SBU (*Strategic Business Unit*). The entire organization has always aimed to build the best loudspeaker systems available in professional audio and special efforts have been made to design this sound reinforcement system. This is recognizable in any of its characteristics: the high sustainable power (despite the small size of the various units), the remarkable sound pressure generated (the sensitivity of a XTMISI element is close to that of the "big" XTLISA line array) and finally a very fast response speed, which is unique in the current state-of-the-art for the professional audio market. While always looking towards technological innovation, X-Treme engineers have focused mainly on a design-related requirement: an extraordinary *compactness*, along with an inevitable fascination of the vertical line array system. Such a technical-emotional mix has generated a sound system that, in all respects, has gone beyond our most ambitious expectations: a 900 W RMS line array module and a 2400 W RMS subwoofer, both only 82 cm wide! From a technical point of view, this is the result of a perfect interaction between components and cabinets, from small-sized furniture to carefully distributed masses and volumes. From an emotional perspective, it is a successful combination of power and high definition.

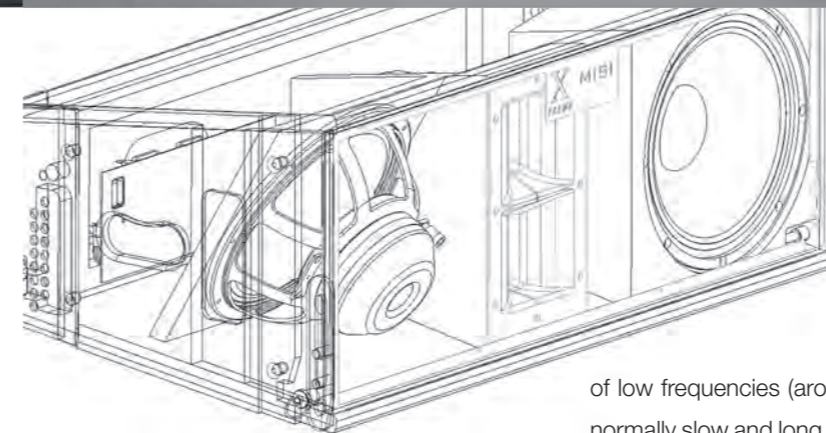

The **Middle-Sized line array** series includes latest-generation vertical line array products capable of satisfying high power and great impact sound reinforcement requirements with very small dimensions. Both the **XTMISI** line array module and the arrayable **XTMISIS** subwoofer (like amplified models **XTMISI/A** and **XTMISIS/A**) have been devised by X-Treme engineers according to a well-defined design philosophy: using good extension woofers at low frequencies and crossing the subwoofers at ultra-low frequencies; this allows the use of normally fast woofers for the reproduction

of low frequencies (around 100 Hz) and the normally slow and long throw subwoofers for frequencies near the lowest audible threshold limit (MAF: *Minimum Audible Field*). By doing this, the woofer-subwoofer coupling is optimized and makes the SPL spatial variation of pressure levels far less critical in the crossover band. Moreover, both models share two common characteristics. The first one is X-Treme RODAP™ (*Robust Design and Prototyping*) technology: a design, prototyping and testing system used for the loudspeaker system cabinets, which can simulate and test various possible configurations

by using CAD 3D tools, ensuring a better exploitation of the components and increasing the speakers' sustainable power. The second common element is a little more difficult to explain, but easier to understand: pure pleasure of listening without limitations.

Automated production technologies and artisan accuracy in every detail: only in this way does a hi-end professional audio system become an authentic X-Treme product.



XTMISIS

System configuration	arrayable double sub.
Power handling RMS	2400 W
Frequency response	40±150 Hz (-3 dB)
Peak SPL (@1 m)	140 dB
Nom. impedance	4 Ohm
Transducers	2x18" neodymium
Input connectors	2 x NL8FC Speakon
Cabinet	birch plywood
Dimensions (WxHxD)	820x450x800 mm
Net weight (Kg)	67
Special version	4+4 Ohm impedance

XTMISIS/A



System configuration	active arrayable double sub.
Amplifier RMS	2500 W - class D digital
Frequency response	40±150 Hz (-3 dB)
Peak SPL (@1 m)	140 dB
Power supply	switching technology 115 or 230 V ± 10%
Input	max +10 dBu - XLR
DSP on board	24 bit/96 kHz (2 preset)
PC network (XT-NET)	RJ45 plug - UTP Cat. 5 cable
Cabinet	birch plywood
Dimensions (WxHxD)	820x450x800 mm
Net weight (Kg)	68,5





MISI™ loudspeaker systems

MISI™



• The brand-new titanium compression drivers are coupled with the innovative aluminium **EIWD™** transducer with proprietary technology; the latter is forged from a dedicated mould which is stiffened through a suitable working process to avoid any resonance. In this way it can generate a totally uniform and coherent wave field, with phased wave fronts.

The **XTMISI** model, designed in a compact size, is a wide band system made up of a 10" woofer tuned according to a *balanced symmetric anti-distortion* configuration (which reduces distortions to a minimum, shows a drastic "natural" cut of the frequency response just below 200 Hz and allows the recovery of no less than 3 liters of volume), a 10" mid-range in a closed enclosure (designed for avoiding any direct reflection on the loudspeaker and equipped with amazing dynamics, in spite of its small dimensions) and a new concept aluminium waveguide horn (EIWD™ - proprietary technology) containing two 1" tweeters. This line array module can be used without a sub-



• The new passive **crossover filter** features **X-MAXO™** proprietary technology, via which the desired loudspeaker system configuration (2-way or 3-way) can be selected through a simple switch of the high current handling terminals. The X-Treme filters have been designed to minimize all phase reductions and distortions, are equipped with active protection devices fitted to the transducers and are made up of highly professional components such as air coils, high insulation capacitors and armored resistors with aluminium heat sinks.

woofer in many of its applications, but, if an extension is required at ultra-low frequencies, the XTMISI unit can be integrated with a floor-aligned or suspended **XTMISIS**, which consists of a high performance pass band subwoofer, equipped with two high power and long throw 18" loudspeakers within a width of just 82 cm! What is more, the XTMISIS has been designed to minimize internal symmetries with a 15 mm thick reinforcement cage in the Canadian birch plywood cabinet: as a result, it perfectly complements the XTMISI module, as it generates a marked depth and a widespread roundness in the reproduction of the sub-sonic frequency spectrum.



• The cone-shaped **components** are manufactured by leading world producers on the basis of the specifications provided by X-Treme engineers. All the loudspeakers are new generation devices (*above and below*: the **10" midrange** and the **10" woofer**): they feature an aluminium basket, cloth suspension, cellulose membrane (the latter with NOMEX®) and a neodymium magnet. Moreover, they are equipped with a heat sink and are characterized by very high power handling and a high frequency response extension.



• On request, the XTMISIS compact double subwoofer can be equipped with a **wheelboard**, which facilitates movement on the ground and also acts as an excellent protective cover when positioned in front of the element.



flying & LIFTING

All the X-Treme single line array elements (both upper modules and arrayable subwoofers) have the **ESAH** (*Easy Suspending And Handling*) suspension system incorporated. This is certified according to UNI standards and makes it easier to create and suspend complex arrays of speakers, quickly and safely. The suspension rods, which are made up of steel alloy pipes and have a series of holes with a 260 mm diameter to provide attachment points, have been designed to support heavy

loads and are the only accessory needed to create suspended or stacked arrays (see the "Flying and Lifting" manual). On the other hand, the 4 **XT-PIN** anchoring pins with ball closure in *martensitic* steel, which were designed with the aid of CAE tools (*Computer Aided Engineering*) and certified according to the UNI 10011 standard, are the only elements necessary to suspend one speaker to another and are directly supplied together with each model (*all included*).



MISI™

MISI™ accessories for SUSPENSION



STD-MISI
Flying bar for MISI™

XT-ANGLE + XT-ANGLERC
See page 29

MISI™ accessories OTHERS



XT-NETINT
Network Interface for XT-NET connection (PC adapter: from USB or RS232 ports to standard RJ45 sockets)



XT-PSB32/8
Patch board 32A - 2 XLR IN, 2 XLR OUT - 4 Speakon OUT NL8MPR



XT-D8P
Connection panel specially designed for line arrays

XTMISIS-SK
Wheelboard for XTMISIS and XTMISIS/A double subwoofer



Mini Line Array loudspeaker systems

The ultra-compact **Mini Line Array** is a three-way sound system suited to theatres and live performances which offers all the advantages of "linear source" technology thanks to the advanced wave-guide horn loading. This product line offers four models of loudspeaker systems, with an intentionally large number of applications, ranging from single speakers right through to array systems for open-air locations, all sharing the same basic requirements: mechanical and acoustic compatibility to achieve a precise directivity control. More specifically, both the bi-amplified **XTMLA/A** module and the active subwoofer **XTMLAS/A**, are equipped with a digital amplifier based on a high-tech switching technology and fitted with an internal programmable DSP (24 bit /96 kHz) that can be controlled from an

external PC thanks to the XT-NET network and its managing software. The different settings of the DSP can be recalled directly by the user with no need for a PC. The tri-amplifiable passive **XTMLA** model has a nominal impedance of *16 Ohm* and it can be wired in parallel with other 4 loudspeakers of the same type to be supplied by a single outer power amplifier. The Mini Line Array system is equipped with a full range of specially designed rigging tools which allow quick and simple deployment in all the intended applications, whether ground supported or flow: the special ESAH flying system makes setting up an entire line array so easy that it can be accomplished by only one technician. No extra rigging hardware has to be assembled - all necessary equipment is fitted into the cabinet.



XTMLA

System configuration	3-way mini line array module
Power handling RMS	500 W
Frequency response (-3 dB)	65÷18,5k Hz
Peak SPL (@1 m)	133 dB
Coverage angle (-6 dB)	120° horizontal
Nom. impedance (bi-amp)	16 (LF), 16 (MF+HF) Ohm
Nom. impedance (tri-amp)	16 (LF), 16 (MF), 16 (HF) Ohm
Transducers	LF 1x8" neodymium MF 1x6" neodymium HF 2x1" titanium
Input connectors	2 x NL8FC Speakon
Cabinet	birch plywood
Dimensions (WxHxD)	640x320x410 mm
Net weight (Kg)	29



XTMLA/A

System configuration	active mini line array module
BI-Amplified RMS	800 + 800 W
Frequency response (-3 dB)	class D digital
Peak SPL (@1 m)	65÷18,5k Hz
Coverage angle (-6 dB)	133 dB
Power supply	120° horizontal
Input	switching technology
DSP on board	115 or 230 V ± 10%
PC network (XT-NET)	max +10 dBu - XLR
Cabinet	24 bit/96 kHz (2 preset)
Dimensions (WxHxD)	RJ45 plug - UTP Cat. 5 cable
Net weight (Kg)	birch plywood
	640x320x410 mm
	31



XTMLAS

System configuration	arrayable double subwoofer
Power handling RMS	2000 W
Frequency response (-3 dB)	40÷150 Hz
Peak SPL (@1 m)	138 dB
Nominal impedance	4 Ohm
Transducers	2x15" neodymium
Input connectors	2 x NL8FC Speakon
Cabinet	birch plywood
Dimensions (WxHxD)	640x450x800 mm
Net weight (Kg)	59,5



XTMLAS/A

System configuration	active arrayable double subwoofer
Amplifier RMS	2500 W - class D digital
Frequency response (-3 dB)	40÷150 Hz
Peak SPL (@1 m)	138 dB
Power supply	switching technology
Input	115 or 230 V ± 10%
DSP on board	max +10 dBu - XLR
PC network (XT-NET)	24 bit / 96 kHz (2 preset)
Cabinet	RJ45 plug - UTP Cat. 5 cable
Dimensions (WxHxD)	birch plywood
Net weight (Kg)	640x450x800 mm
	61



Mini Line Array loudspeaker systems

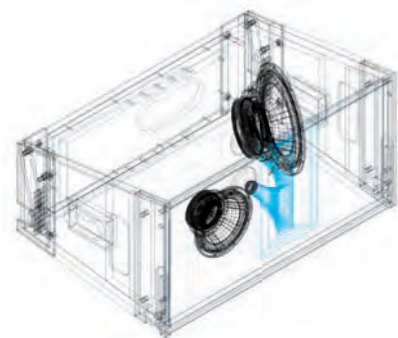

The **XTMLA** element (and the active bi-amplified **XTMLA/A** one) have been designed for the main purpose of obtaining a wide horizontal and vertical coverage. This goal has been achieved by a new wave guide for the high section which is capable of producing a 120° coverage on a horizontal plane. By angling a single wave guide, XTMLA is able to achieve a maximum 15° angle on a vertical plane between each array module. In fact, the corners of the XTMLA's trapezoidal enclosure have been

designed to achieve a 2 x 7.5° angle when two loudspeaker systems are coupled. Thanks to a successful coupling across the audible spectrum, XTMLA generates a coherent wave front on a wide area with very tiny variations in the frequency response and sound pressure level. The accuracy, the transparency, the great *headroom* and the flexibility in the approach of the Mini Line Array system to sound reinforcement open up new horizons for the sound system design.



• Being an integral part of the speakers, the **ESAH flying system** is equipped with a front fastener which ensures the correct distance between various units, while the rear fastener is used to adjust their vertical orientation.



• The brand-new titanium compression drivers are paired with the innovative aluminium **EIWD™** transducer with proprietary technology; it is forged from a dedicated mould which is stiffened through a suitable working process to avoid any resonance. In this way it can generate a totally uniform and coherent wave field, with phased wave fronts.

• Although the new **XTMLAS** double subwoofer is extremely light in weight and small in size for a product containing two 15" loudspeakers, it can be furnished, on request, with a **board with wheels**; an ideal accessory, thanks to its maneuverability and the cabinet's protection during transport and use.

• Due to a successful coupling across the audible spectrum and to innovative cone-shaped internal **components** (below: the **6" midrange** and the **8" woofer**),

the speaker systems generate a coherent wave front on a wide range with minute variations in the frequency response and sound pressure level.



HDSC™ & RODAP™

• The ultra-resistant **external coating (HDSC™)** of the loudspeaker systems is composed of a special heat-stretched polyurethane resin and of a water-repellent, non-scratch gel-coat which is weatherproof and ensures perfect integrity over time. The speaker **sections** and **loadings** (illustration: the exploded view and cutaway of the XTMLAS subwoofer) have been designed to optimize the performance of the internal components.

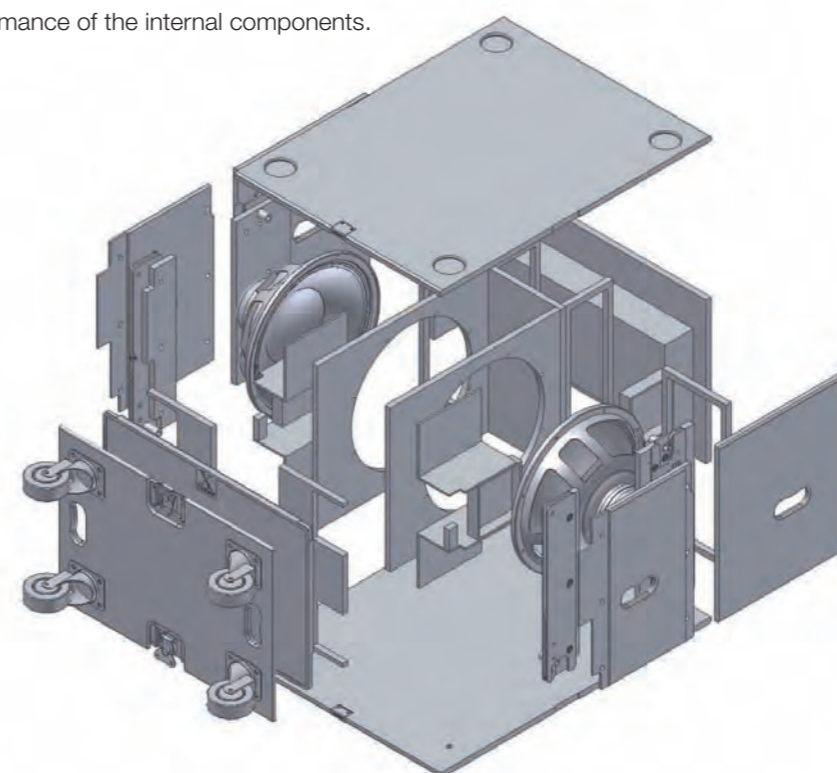

• There are very few companies using standardized and systemic tools during the strategic phase of product design. The X-Treme business unit, right from its establishment, has not only made the most innovative design techniques its own (from QFD to DFX techniques, from CAE tools to the most advanced 3D drawing and simulation software programs), but has also marked out its own route, **RODAP™**, which, by involving all the company's functions, defends the wealth of knowledge and the identification of new products. The result of this original approach is a number of *new product lines* per year that exceeds 1 (about 3 every 2 years) and a consequent *Mean Time to Market* that is less than 6 months.

MLA

MLA accessories for SUSPENSION



STD-MLA
Flying bar for Mini Line Array

XT-ANGLE + XT-ANGLERC
See page 29

MLA accessories OTHERS



XT-NETINT
Network Interface for XT-NET connection
(PC adapter: from USB or RS232 ports to standard RJ45 sockets)



XT-PSB32/8
Patch board 32A - 2 XLR IN, 2 XLR OUT -
4 Speakon OUT NL8MPR



XT-D8P
Connection panel specially designed for
line arrays

XTMLA-PORT
Stand holder
for Mini Line
Array "portable"
configuration



XTMLAS-SK
Wheelboard for XTMLAS and XTMLAS/A
double subwoofer





Mini Line Array

loudspeaker systems

installation typologies

FLYING SYSTEM

When a curved array is suspended (*flying system*), a combination of cylindrical and spherical waves are generated. Although the propagation of pure cylindrical waves is not always possible, a distance-related attenuation of 3 dB can be achieved by listening to the audio system in the near field and by directing the system correctly on the audience area.

The result is a very wide coverage capacity and a high fidelity listening experience, with an excellent stereophonic image and outstanding clarity.

The suspension of line arrays represents, therefore, an optimum solution whenever the sound coverage of large indoor or outdoor spaces is required.

For each anchoring point, the flying system is rated for a maximum of **12 XTMLA** units.



GROUND STACKING

The positioning on stage (*stacking system*) creates a positive perception of the sound image from the stage itself, especially when small venues have to be sound reinforced. Stacking also offers higher SPL on low frequencies thanks to the enhanced floor coupling.

In addition, for geometric reasons, a floor-stacked array can provide a more extended vertical coverage than a flown one. This is why stacking is used for sound configurations in small places, where only a few elements can optimize the audience coverage.

The stacking system is sized for a maximum of **12 XTMLA** units.

For PORTABLE PA users (bands, musicians, performers & entertainers)

The basic *Portable* passive system is made up of **2 XTMLA** elements and **2 XTMLAS** subwoofers each channel, suitable for live and musical events in small-sized areas. It can be installed in a very easy manner without using any special accessories. The dimensions of this system are quite small, so it is suitable for bands, entertainers or rental companies, through loudspeaker systems which are compact and easy to transport, while offering an accurate response and wide coverage.



The **XT-ANGLE** is an electrical-mechanical device which has a motorized linear actuator for the remote adjustment of the vertical tilting of X-Treme arrays. The *flying bar* contains a worm screw which, when set to rotate by the motor, allows the lengthways movement of the coupling block and therefore the tilting of the *flying bar* (depending on the weight distribution of the array). The threaded element only sustains longitudinal forces, while the traction of the hook lies directly on the structure of the rod, sliding under it on a layer of Teflon. This system, which is patent pending, offers professional riggers possibilities that have never been seen before.

In actual fact, it allows:

- a) the array to be lifted without having to decide the anchoring point beforehand;
- b) more precise angles to be set, compared to those offered by the anchoring hole of a traditional rod;
- c) the system to be adjusted after mounting, without ever having to bring it back down to the ground. In actual fact, as soon as the value of the angle is set in sexagesimal degrees, either positive or negative with respect to the horizontal line, on the handy remote control (**XT-ANGLERC**), the motor will quickly position the array at the desired

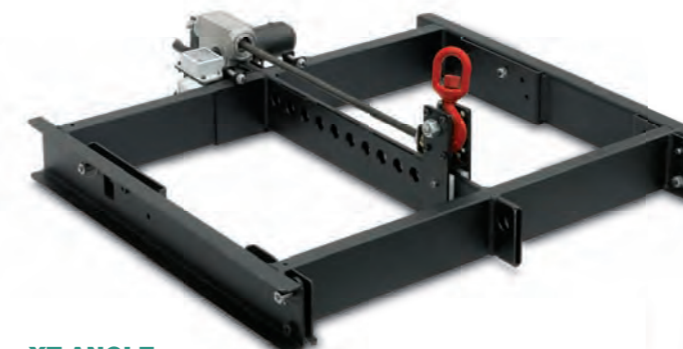

XT-ANGLE
Electro-mechanical device for setting the pitch of line array systems (*flying bar NOT included*)

XT-ANGLERC
Remote controller for XT-ANGLE with bright display (cable included, 10 m in length)



angle (*pitch*); a deep needle positioned on the border of the *flying bar* will verify the precision of the angle via feedback control, directly on the display of the remote control. If an installation design is carried out using XTI forecasting software, the array of the α vertical pointing angle just needs to be hung as suggested by the program itself (assuming that the anchoring height and *splay angles* are also the suggested ones).

Complex operations are handled with complete safety, with no effort and in record times: with this accessory you can get straight to the... angle!





X-TREME



X-Treme Installer (XTI) is proprietary software that has been created and developed by the Sound Corporation R&D department to produce a 3D virtual installation of any X-Treme audio system; it therefore allows the user to calculate the distribution of the sound produced by such systems in a three-dimensional space, under *free field* conditions. A choice of listening areas can be set and the different systems can be positioned as preferred, either as single sources (single speaker) or as line arrays that are vertical (made up of various *upper modules*) or horizontal (various *subwoofers*), in a three-dimensional virtual space. The software provides, as output, the distribution of the maximum continuous SPL that can be obtained in the various areas of the simulated audience, with different representations, in wide band or by octaves. For installation of the arrays, the software

automatically calculates an ideal geometrical configuration and the α vertical pointing angle, starting with an analysis of the sound field produced for a range of possible configurations. XTI therefore incorporates all the characteristics of a very advanced "aiming" software, with some ingenious additions: for example, the calculation on a three-dimensional basis produces a more complete and complex visualization of the space to be reinforced. The software is essentially based on the phenomenon of *interference*, which allows a precise forecast of the phenomena of interaction between the various speakers, with much more accurate results, for example, than those that can be obtained with an algorithm based on *Ray Tracing*; such precision becomes inalienable to describe the directivity of complex audio systems such as the grouping of several array speakers.

All the new X-Treme self-powered speakers are equipped with a DSP (*Digital Signal Processor*) that has a 24 bit audio resolution and 96 kHz sampling frequency. Via UTP (*Unshielded Twisted Pair*) cat. 5 cable and RJ45 plugs, the **XT-NET** network allows the owner, to create a daisy-chain connection of any number of speakers and to interface directly with them via PC (there is a special adapter for this purpose - XT-NETINT - which enables you to move from the network cable to USB or RS232 ports). The control software, which is intuitive and *user friendly*, thanks to a strong use of colours (*see screenshot*), permits the user to perform a series of audio interventions and to monitor the temperature of the amplifiers.

Several operations can be carried out on the reproduced sound, which can be heard in real time and can be directly verified on the frequency response graph, thanks to an *eight band parametric equalizer* (the curves can be traced directly with the mouse on the frequency response diagram), 2 *crossovers* for the cut of the band boundaries and the same number of *shelving filters*, *gains*, *delays* and *mute*, *switch-on* and *auto-switch off functions*. Another 2 graphs plot the *log* of the temperature status and any interventions of self-protection that might occur within the amplifiers. Finally, the crossover filters and limiters can be preset and updated using the same software, by loading a file issued by X-Treme Audio.

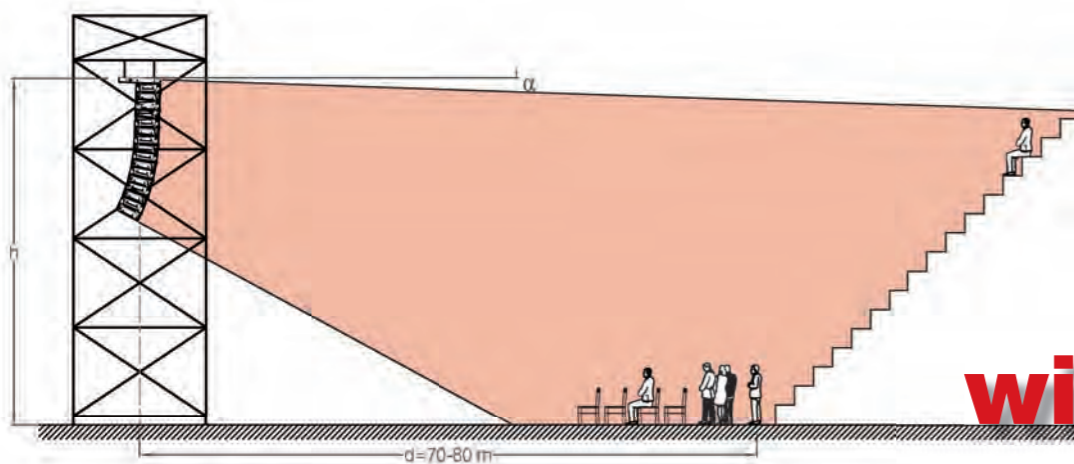
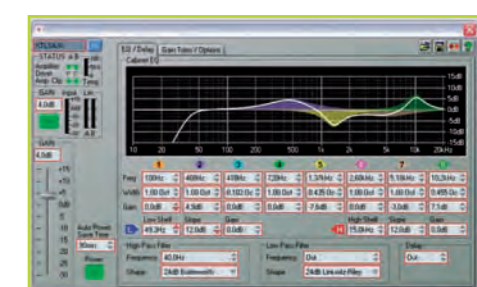
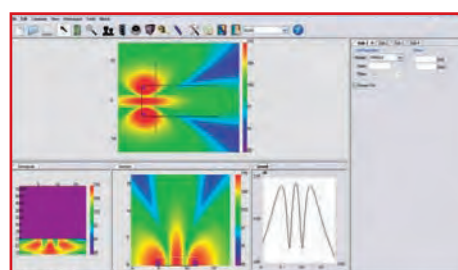
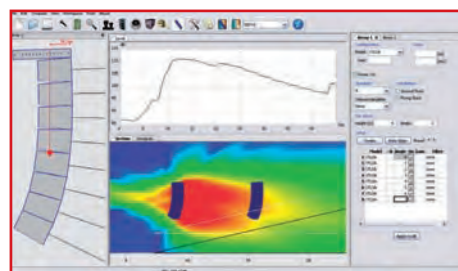

with

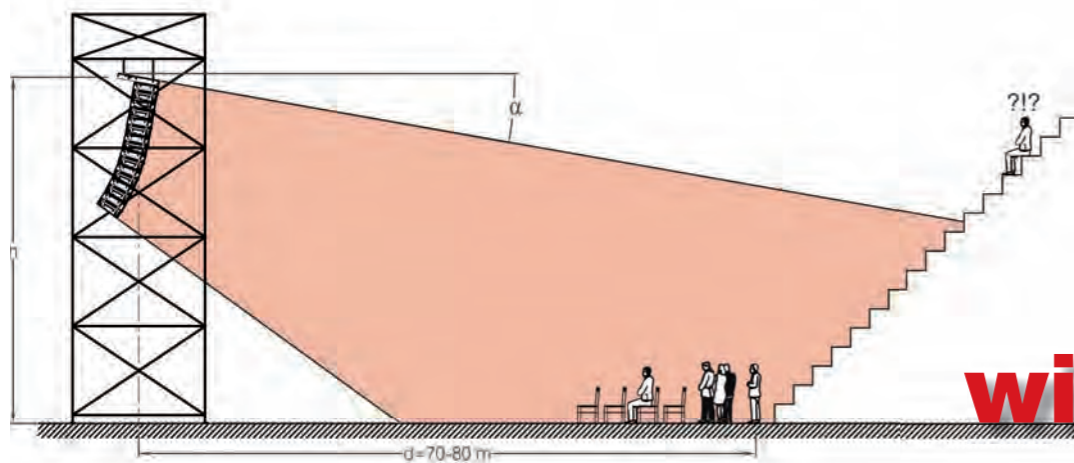

without?

or



monitor line

monitor line stage monitors

A good stage monitor has several basic requirements: constant directivity, wide coverage, feedback control, a pleasant appearance, stability (we all know how musicians like to let loose on stage!) and lightness (sound engineers need to reduce their efforts and quite rightly so!). During the design of the new **Monitor Line** (models: **XTMON12** and **XTMON15**, 450 and 500 W respectively, plus the much requested amplified versions **XTMON12/A** and **XTMON15/A**), the X-Treme engineers

took the precious suggestions of musicians seriously, creating products with an attractive design, avant-garde components, an *on board* amplifier with a latest generation DSP and a level of detail and finish reflecting the painstaking attention to detail, which is typical of the X-Treme business unit (a practical example is the X-Treme logo in relief). As well as being a pleasure to look at, the new X-Treme monitors are always stable, literally "*anchored to the stage*", in addition to being completely free from vibrations, even at high powers; this is guaranteed both by the special configuration of the chassis in Canadian birch plywood and by its thickness - no less than 18 mm. The choice to use ab-

solutely reliable quality audio components, with no compromises or restrictions in cost, has brought the efficiency of these products to the top of their range, thanks also to the use of a coaxial loudspeaker in neodymium with titanium tweeter, 3" coil and 80° dispersion angle. What is more, the crossover network of passive speakers minimizes the phase rotations and is made up of air coils, high insulation capacitors and armored resistors with aluminium heat sinks.

With this new generation of stage monitors, not only will the most demanding musicians be fully satisfied, but also the most meticulous audiophiles!



XTMON12

System configuration	coaxial stage monitor
Power handling RMS	450 W
Frequency response (-3 dB)	55÷18k Hz
Peak SPL (@1 m)	132 dB
Coverage angle (-6 dB)	80° horizontal, 80° vertical
Nominal impedance	8 Ohm
Transducers (coaxial)	LF 1x12" neodymium HF 1x3" titanium
Input connectors	2 x NL4FC Speakon
Cabinet	birch plywood
Dimensions (WxHxD)	520x333x475 mm
Net weight (Kg)	19,5



XTMON15

System configuration	coaxial stage monitor
Power handling RMS	500 W
Frequency response (-3 dB)	55÷18k Hz
Peak SPL (@1 m)	133 dB
Coverage angle (-6 dB)	80° horizontal, 80° vertical
Nominal impedance	8 Ohm
Transducers (coaxial)	LF 1x15" neodymium HF 1x3" titanium
Input connectors	2 x NL4FC Speakon
Cabinet	birch plywood
Dimensions (WxHxD)	540x360x535 mm
Net weight (Kg)	22,5

powered monitors

monitor line stage monitors

The brand new **self-powered monitors** have an *on board* final module with *switching* technology for bi-amplification (800+800 W); it is positioned in a special recess, to avoid any mechanical stress present in the internal volume containing the loudspeaker. The power supplied allows the highest dynamics with absolutely no distortion. The amplifier's DSP performs remote controls (temperature control, status control, etc...) and acoustic optimization. Customization

can be achieved by the user, choosing between 2 *factory presets* and by using input equalization, *shelving* filters and high-pass/low-pass filters to obtain the desired sound. All the equipment is housed in a single speaker, with no need for amplifiers or external processors, racks or connecting cables on the stage. Both versions, active and passive, implement, either electronically or via signal processing, *notch* and band elimination filters to counter *feedback*.



XTMON12/A

System configuration	active stage monitor
BI-Amplified RMS	800 + 800 W - class D digital
Frequency response (-3 dB)	55÷18k Hz
Peak SPL (@1 m)	132 dB
Coverage angle (-6 dB)	80° horizontal, 80° vertical
Power supply	switching technology 115 or 230 V ± 10%
Input	max +10 dBu - XLR
DSP on board	24 bit/96 kHz (2 preset)
PC network (XT-NET)	RJ45 plug - UTP Cat. 5 cable
Cabinet	birch plywood
Dimensions (WxHxD)	520x333x475 mm
Net weight (Kg)	21



XTMON15/A

System configuration	active stage monitor
BI-Amplified RMS	800 + 800 W - class D digital
Frequency response (-3 dB)	55÷18k Hz
Peak SPL (@1 m)	133 dB
Coverage angle (-6 dB)	80° horizontal, 80° vertical
Power supply	switching technology 115 or 230 V ± 10%
Input	max +10 dBu - XLR
DSP on board	24 bit/96 kHz (2 preset)
PC network (XT-NET)	RJ45 plug - UTP Cat. 5 cable
Cabinet	birch plywood
Dimensions (WxHxD)	540x360x535 mm
Net weight (Kg)	24

MONITOR accessories



XT-NETINT

Interfaccia per connessione alla rete XT-NET (Adattatore per PC: dalle porte USB o RS232 alle prese standard RJ45)

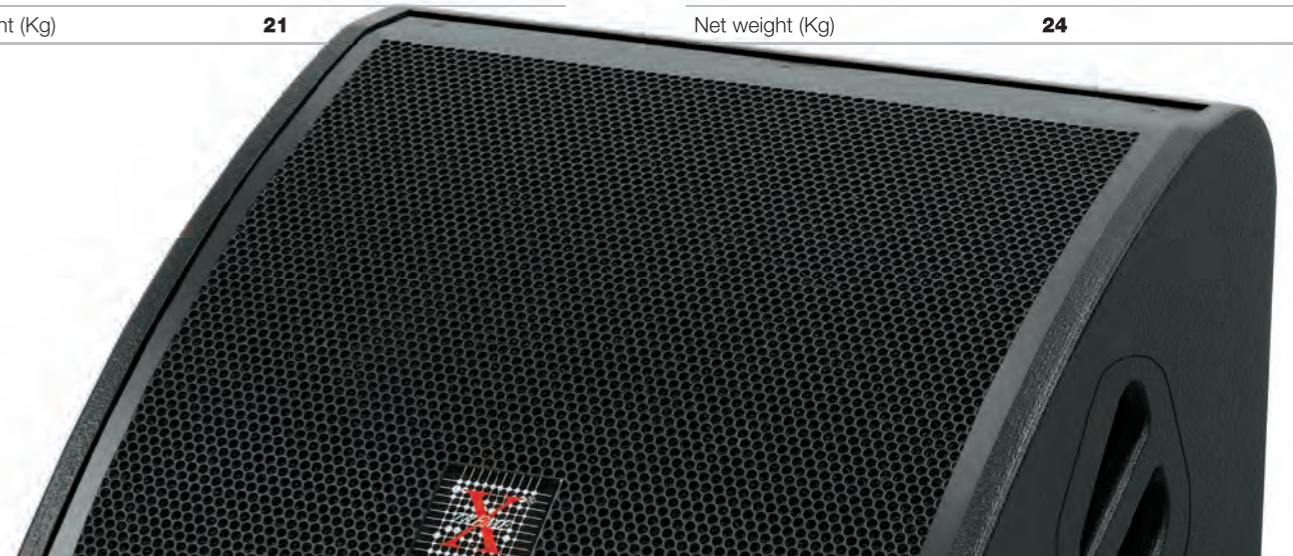



classic line

classic line

targets

Audio distributors - Rental companies - Productions of musical events - Show agencies - Event promoters/organizers - Owners of public entertainment venues

applications

- Concert & touring**
 - small • **medium** • large scale
- Arrayable FOH enclosures**
- Central clusters, front fill, side fill, delay towers, etc...**
- Open-air events,** public squares, etc...
 - small • **medium** • large scale
- Portable PA systems** for musicians, bands and entertainers
 - small • medium size
- Stadiums, Sports halls, Arenas**
- Theme parks, Circus shows**
- Theatres, Auditoriums, Music halls**
- Places of worship**
- Fixed installations**
 - small • medium • large size
- Live clubs, Music pubs** and other Live Performance Venues
 - small • **medium** • large size
- Dance clubs, night clubs and lounge bars**
 - small • medium • large size
- Multi-purpose venues,** Recreational and cultural structures, Conference centers and Fairs
- Cinemas**
- HO.RE.CA.** (Hotel, Restaurant and Café)
- Corporate A/V events**
- Festivals, Exhibitions, Competitions** and other public events

technologies

HDSC™

RODAP™

ESAH flying system

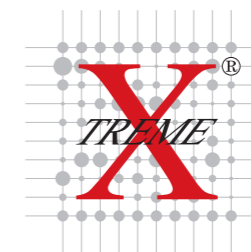

classic line loudspeaker systems

The **Classic Line** speakers have undergone a careful restyling, in keeping with the company's philosophy for continuous improvement (*kaizen*): the wood thickness of Canadian birch plywood has been reduced from 19 to 15 mm and the 4 wheels have been removed from the rear of the cabinet. They are particularly suitable for use in musical performances

held in open spaces, arenas, theatres, sport halls and anywhere live music can be played. The design philosophy of these products is based on optimizing the control of the horizontal and vertical dispersion angle as well as the frequency response linearity, while maintaining the extreme reliability of the whole system under any conditions of use.

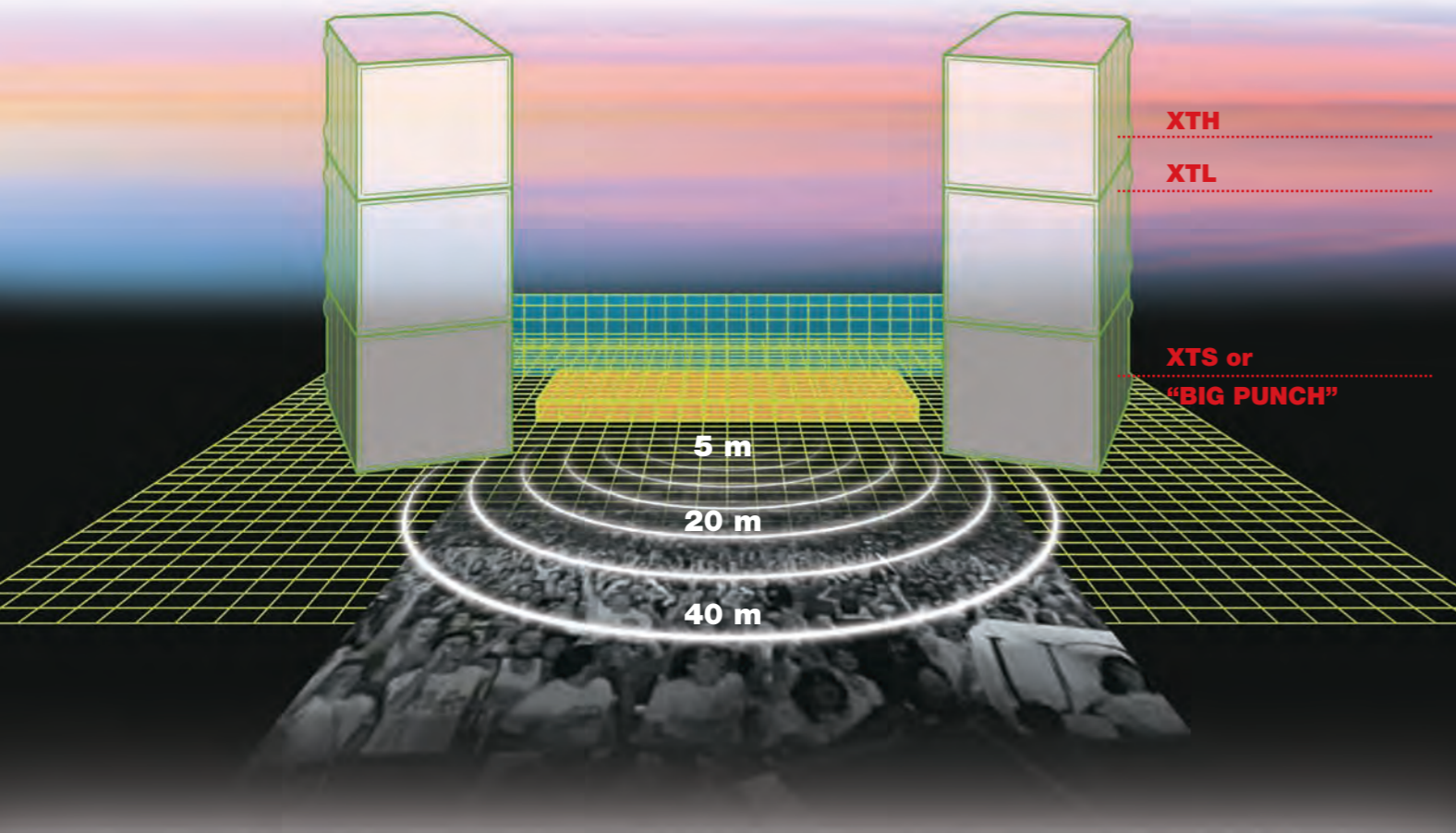

In order to widen the coverage angle, various speakers can be used together until a "cluster" configuration is formed, with an arrangement prompted by the special shape of the cabinets (see the figure with the dispersion angles).

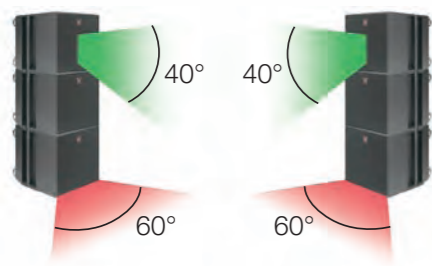

60° configuration

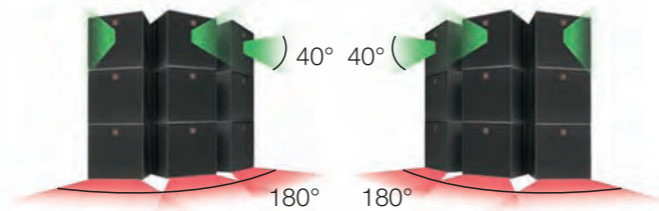

180° configuration



XTH

System configuration	2-way (MF - HF) speaker
Power handling RMS	550 W
Frequency response (-3 dB)	150÷18k Hz
Peak SPL (@1 m)	137 dB
Coverage angle (-6 dB)	60° horizontal, 40° vertical
Nominal impedance	8 Ohm
Transducers	MF 1x12" neodymium HF 1x2" titanium
Input connectors	2 x NL4FC Speakon
Cabinet	birch plywood
Dimensions (WxHxD)	580x580x620 mm
Net weight (Kg)	48

XTL

System configuration	woofer
Power handling RMS	850 W
Frequency response (-3 dB)	50÷150 Hz
Peak SPL (@1 m)	137 dB
Nominal impedance	8 Ohm
Transducers	LF 1x18"
Input connectors	2 x NL4FC Speakon
Cabinet	birch plywood
Dimensions (WxHxD)	580x580x620 mm
Net weight (Kg)	42,5

XTS

System configuration	subwoofer
Power handling RMS	1200 W
Frequency response (-3 dB)	30÷80 Hz
Peak SPL (@1 m)	137 dB
Nominal impedance	8 Ohm
Transducers	LF 1x18" neodymium
Input connectors	2 x NL4FC Speakon
Cabinet	birch plywood
Dimensions (WxHxD)	580x580x620 mm
Net weight (Kg)	37,5

"BIG PUNCH"

For a detailed description see page **58**

classic line
loudspeaker systems

- The break-proof **protection grid** provides a high level of sound permeability; the high-resistance **sponge** protects the speakers from weather agents.



- The ultra-resistant **external coating** of the loudspeaker systems (**HDSC™**) consists of a four working phase process, which guarantees its perfect integrity over time. The **cabinets**, composed of a 15 mm thick birch plywood, are internally reinforced and tongue-and-groove jointed;



- The height of the rubber anti-slip **feet** can be adjusted in order to perfectly adapt the speaker to any surface and to be accurately pointed at various angles for stacked systems.



- The steel **tie rods** and the **suspension ring hooks** are certified for loads that are five times higher than the currently used ones: the safety level established during design phase was, in fact, set at 5.



- The two **supports** for the passage of the anchorage band provide firm fastening and the creation of angled clusters.



- The flying system includes accessories such as **graduated joints** and **ball-lock pins (XT-PINS)**, which are easy and quick to use. The creation and installation of complex clusters becomes an operation that takes just a few minutes, in extremely quick and safe conditions.



- On request, all the new Classic Line speakers are provided with a **wheelboard** that aids the handling of the various elements and protects them from any possible knocks during transport.

- The **handles** are a part of the exclusive and integrated **ESAH flying system** and are also used for moving and carrying with extraordinary ease and manageability thanks to the comfortable anti-slip grip.

classic line: long throw loudspeaker systems

The long-throw system represents extraordinary innovation in the field of professional sound systems for great distances. The modern "line array" principles have been applied to traditional systems: the **XTLT** (X-Treme Long Throw) loudspeaker system does, in fact, integrate the "Classic"

configuration. It should be placed on top of the XTH unit, thus generating a "mixed" sound system. The resulting long-range sound system generates mainly cylindrical rather than *spherical waves* in the mid and high ranges by vertically arranging various homogeneous sources.

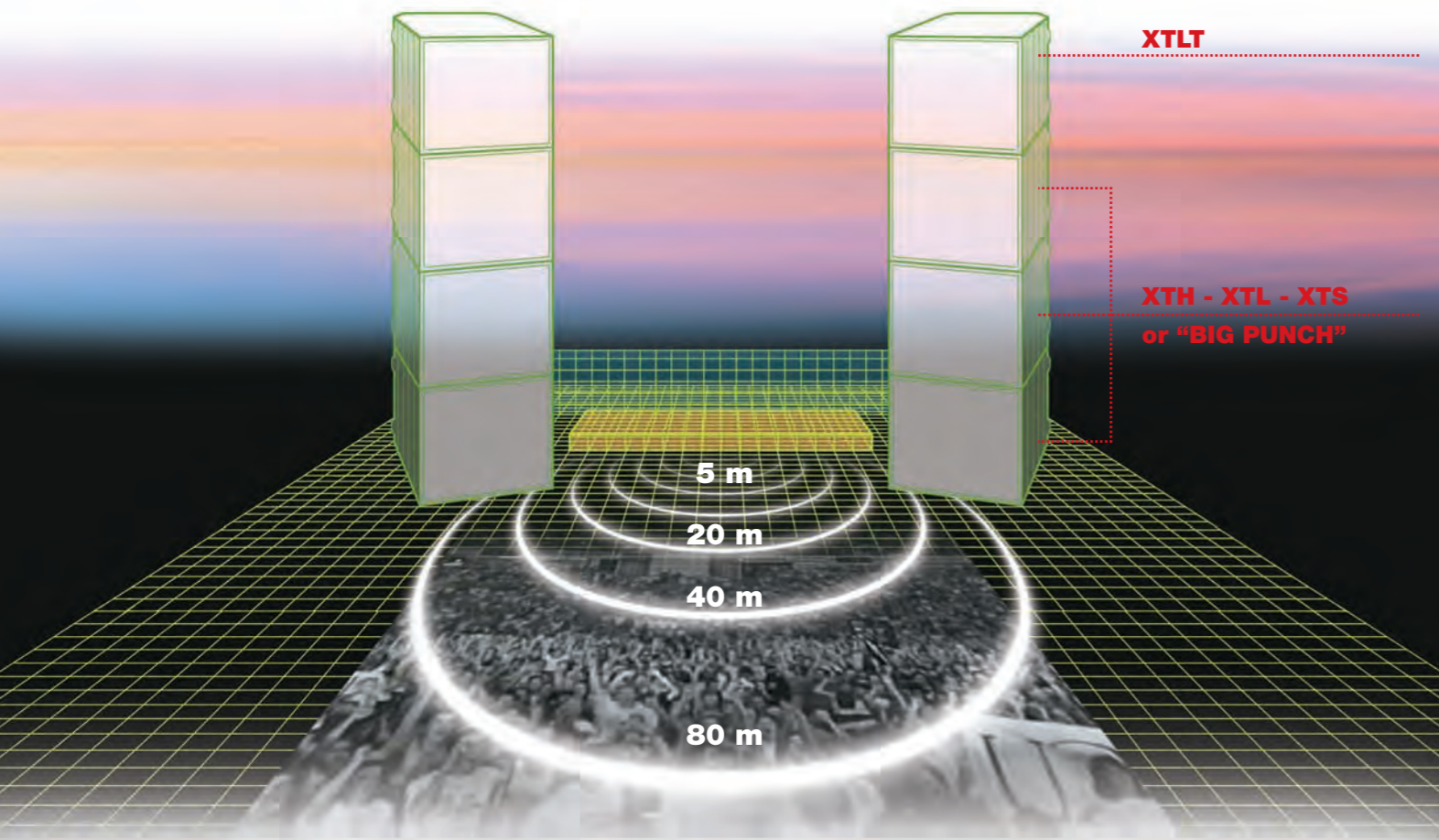

In order to widen the coverage angle, various speakers can be coupled until a "cluster" configuration is formed (see figure).

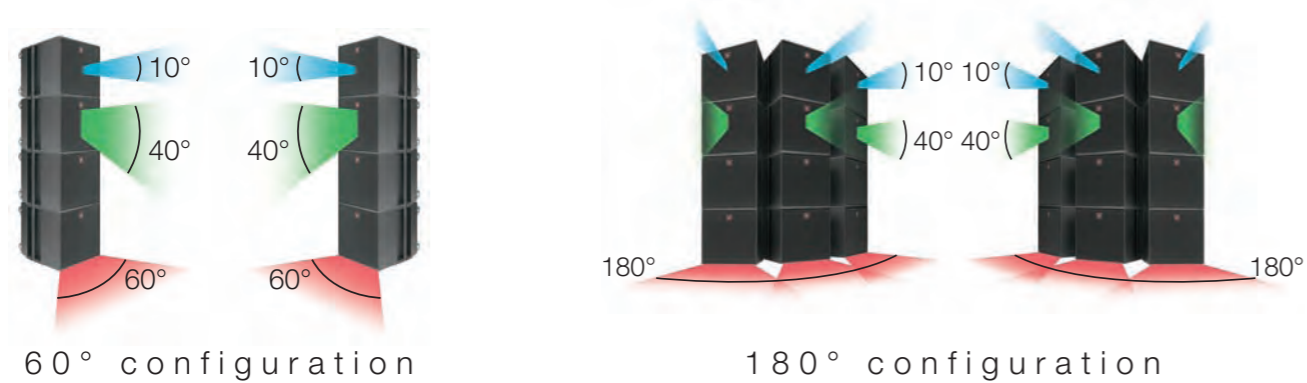

XTLT

System configuration	2-way (MF - HF) long throw module
Power handling RMS	460 W
Frequency response (-3 dB)	150÷20k Hz
Peak SPL (@1 m)	140 dB
Coverage angle (-6 dB)	60° horizontal, 10° vertical
Nominal impedance	4 Ohm
Transducers	MF 3x6" neodymium HF 2x1" titanium
Input connectors	2 x NL4FC Speakon
Cabinet	birch plywood
Dimensions (WxHxD)	580x580x620 mm
Net weight (Kg)	50



classic line: long throw
loudspeaker systems

XTLT

• The **section** and **loading** of the loudspeaker systems are optimized depending on the transducers in order to increase efficiency and to guarantee the maximum extension in terms of frequency response.



• The **horn** loaded system can generate cylindrical wave fronts that attenuate by only 3 dB per doubling of distance, instead of 6 dB, as in the case of traditional systems. The **tweeter unit** is made up of two compression drivers coupled to a dual-wave guide capable of radiating a coherent and flat wave front.

• The passive **crossover filter** is made by using highly professional components such as air coils, high-insulation condensers and armored resistors with aluminium heat sinks.

• The latest-generation custom-made **components** assure a very high power retention and a wide dynamic range. In particular, the **6" midranges** are designed to generate a flat wave front without any internal diffraction.

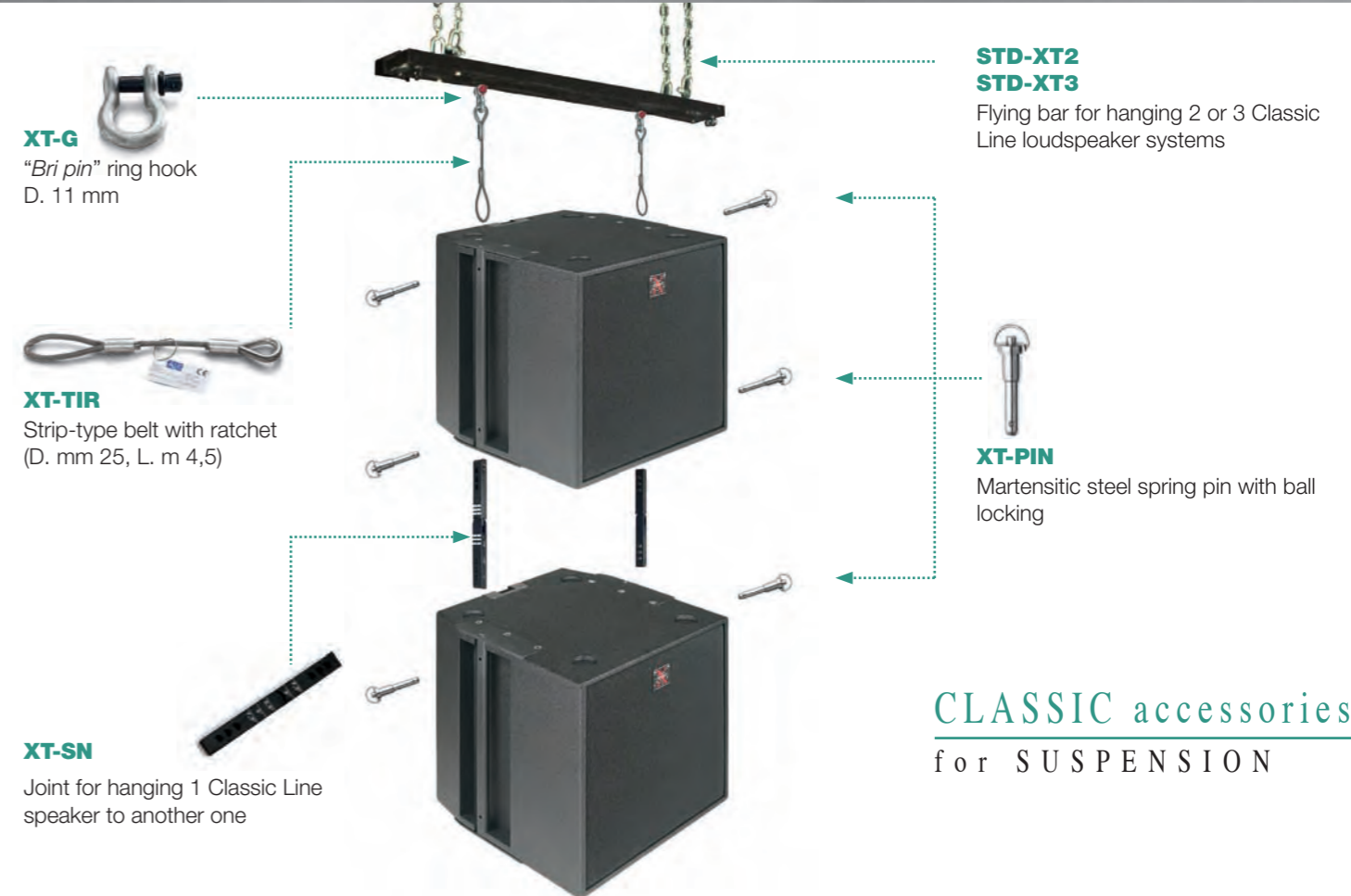

XT-G
"Bri pin" ring hook
D. 11 mm

XT-TIR
Strip-type belt with ratchet
(D. mm 25, L. m 4,5)

STD-XT2
STD-XT3
Flying bar for hanging 2 or 3 Classic Line loudspeaker systems

XT-PIN
Martensitic steel spring pin with ball locking

XT-SN
Joint for hanging 1 Classic Line speaker to another one

CLASSIC accessories
for SUSPENSION



XT-KITSTD
Flying kit for hanging 1 Classic Line speaker to the STD-XT2 or STD-XT3 bars



XT-KITCLA
Flying kit for hanging 1 Classic Line speaker to another one



XT-TF
Tie rod D. 8A/A
L. 350-500-650 mm

CLASSIC accessories
OTHERS



XTCLASSIC-SK
Wheelboard for all the Classic Line speakers

XT-COVER
Protection enclosure for the Classic Line speakers



XT-PSB32/4
Patch board 32A - 2 XLR IN, 2 XLR OUT - 4 Speakon OUT NL4MPR

X-ONE



targets

Audio distributors - Rental companies - Private/public corporations or institutions - Show agencies - Event promoters/organizers - Owners of public entertainment places - Musical instrument retailers - Architects/designers - Audio installers

applications

- Concert & touring**
 - small • medium • large scale
- Arrayable FOH enclosures**
- Central clusters, front fill, side fill, delay towers, etc...**
- Open-air events,** public squares, etc...
 - small • medium • large scale
- Portable PA systems** for musicians, bands and entertainers
 - small • medium size
- Stadiums, Sports halls, Arenas**
- Theme parks, Circus shows**
- Theatres, Auditoriums, Music halls**
- Places of worship**
- Fixed installations**
 - small • medium • large size
- Live clubs,** Music pubs and other Live Performance Venues
 - small • medium • large size
- Dance clubs,** night clubs and lounge bars
 - small • medium • large size
- Multi-purpose venues,** Recreational and cultural structures, Conference centers and Fairs
- Cinemas**
- HO.RE.CA.** (Hotel, Restaurant and Café)
- Corporate A/V events**
- Festivals,** Exhibitions, Competitions and other public events
- Stage monitor near-field, far-field**

technologies

HDSC™

RODAP™

ESAH flying system

X-MAXO™

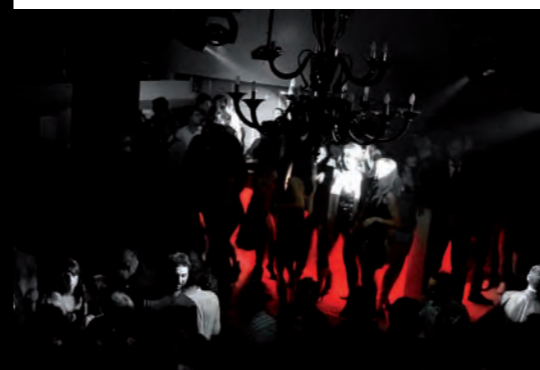

Single Point arrayable multi-purpose Source

It is not always easy to follow one's inner voice, but it is the best way to take sides and to assert oneself. This principle applies to human relationships, but it can be also applied to the sound reinforcement systems. The choice of a quality system, both in external environments and in fixed installations, deserves a product line with unique and special contents: the **X-ONE** series. Its very name tells us about the extremely innovative character of this line: in a few words, the XTO model (2-way, full range, 800 W RMS) can be defined as the first **single point arrayable multi-purpose** source in the professional audio sector. This definition contains all the distinctive characteristics of this amazing element:

1. the presence of a *coaxial* component which, by reproducing the low and medium-high frequencies from a single physical point in space (*single point source*), generates a uniform and coherent emission of the whole musical program within a 60° solid angle (sound image cone). This technical solution leads to an excellent sonic accuracy, particularly in the midrange where an outstanding clarity of the voice and soloist instruments can be noticed;
2. an extreme effectiveness in *modularity* (*arrayable*): a number of multi-way traditional sources (required for power or coverage purposes) often generate phenomena of destructive interferences or aliasing in frequency, while the X-ONE speaker systems, thanks to their innovative axis configuration, incorporate woofers and tweeters which are coherent with each other;
3. a marked *polyvalence* (*multi-purpose*): the X-ONE loudspeaker systems, being small-sized and very compact, can be used both in small environments such as bars and hotels and in larger settings such as sports halls, theatres, auditoria, etc... with a timbre and sound quality which is always above the current standards for this market segment.



XTO

System configuration	single point source speaker
Power handling RMS	800 W
Frequency response (-3 dB)	50÷20k Hz
Peak SPL (@1 m)	136 dB
Coverage angle (-6 dB)	60° conical
Nom. impedance (full range)	8 Ohm
Nom. impedance (bi-amp)	8 (LF), 8 (HF) Ohm
Transducers (coaxial)	LF 1x15" neodymium HF 1x2,83" titanium
Input connectors	2 x NL4FC Speakon
Cabinet	birch plywood
Dimensions (WxHxD)	500x500x530 mm
Net weight (Kg)	23



XTOS

System configuration	arrayable subwoofer
Power handling RMS	1000 W
Frequency response (-3 dB)	35÷200 Hz
Peak SPL (@1 m)	133 dB
Nominal impedance	8 Ohm
Transducers	LF 1x15" neodymium
Input connectors	2 x NL4FC Speakon
Cabinet	birch plywood
Dimensions (WxHxD)	500x500x533 mm
Net weight (Kg)	28,5



XTODS

System configuration	double subwoofer
Power handling RMS	2000 W
Frequency response (-3 dB)	33÷200 Hz
Peak SPL (@1 m)	139 dB
Nominal impedance	4 Ohm
Transducers	LF 2x15" neodymium
Input connectors	2 x NL4FC Speakon
Cabinet	birch plywood
Dimensions (WxHxD)	1060x500x630 mm
Net weight (Kg)	62



• The new **crossover filter** inside the XTO allows the outputs to be changed from a full range configuration to a bi-amplified configuration. It features **X-MAXO™** technology and is made up of 1.5 mm copper coils, which contain ferrite for a better heat dissipation



• A **coaxial loudspeaker** with neodymium magnet, aluminium basket and cloth suspension with NOMEX® is specially designed to create high performance and efficient single point source systems. Thanks to a 2.83" sandwich coil, it maintains the power handling and frequency response extension unchanged over time.



• The painted and pre-galvanized metal sheet **terminal board** is rigidly riveted to the cabinet rear cover and ensures a fast and safe attachment of the power signal cables through Neutrik Speakon® connections

Infinite system configurations!



XTO + XTOS

XTO + XTODS



STD-ONEBAR

Vertical flying bar for hanging an XTO or XTOS speaker (2 XT-PIN included)



Quick-fly system

From the early design phase, the X-Treme engineers use to develop better techniques to turn the assembly of the various systems into a fast and safe operation. The X-ONE line suspending accessories were created with the specific purpose of making the installers' work easier. In particular, by exploiting the great versatility of the different elements, the X-Treme designers provided **2 different solutions** for suspending the XTO and XTOS speakers, depending on their intended use. As a rule, the first system (the "fixed" one) is used for fixed installations to create horizontal sets of speakers in which the inclination between the elements is adjustable, while the second system (known as "quick-fly") can be used to create vertical clusters in just a short period, which are mostly suitable for touring musical events.

Both flying systems are designed for not more than **3 XTO or XTOS** elements.



XT-KITONEV

Flying kit for securing an XTO or XTOS speaker to another one to create vertical clusters



XT-TF

Strip-type belt with ratchet (D. mm 25, L. m 4,5)

X-ONE accessories for SUSPENSION

XT-GN

Hook for attachment to a rigging system



STD-ONE

Horizontal flying bar for hanging an XTO or XTOS speaker to create horizontal clusters (2 XT-PIN included)

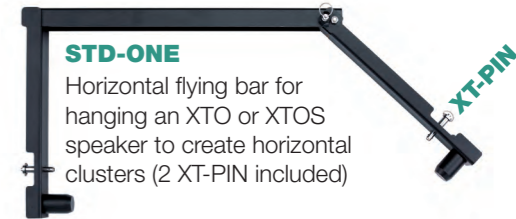

Fixed system

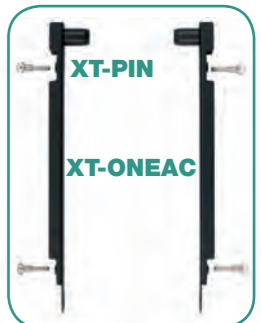

XT-KITONEH

Flying kit for securing an XTO or XTOS speaker to another one to create horizontal clusters

X-ONE accessories OTHERS



XT-ST125

Adjustable-height three-legged stand for an XTO speaker



XT-SNO

Joint for subwoofer-upper module connection suitable for vertical inclination adjustment



XT-ST100

Adjustable-height stand holder for subwoofer-upper module connection



XTODS-SK

Wheelboard for XTODS subwoofer

deflector line

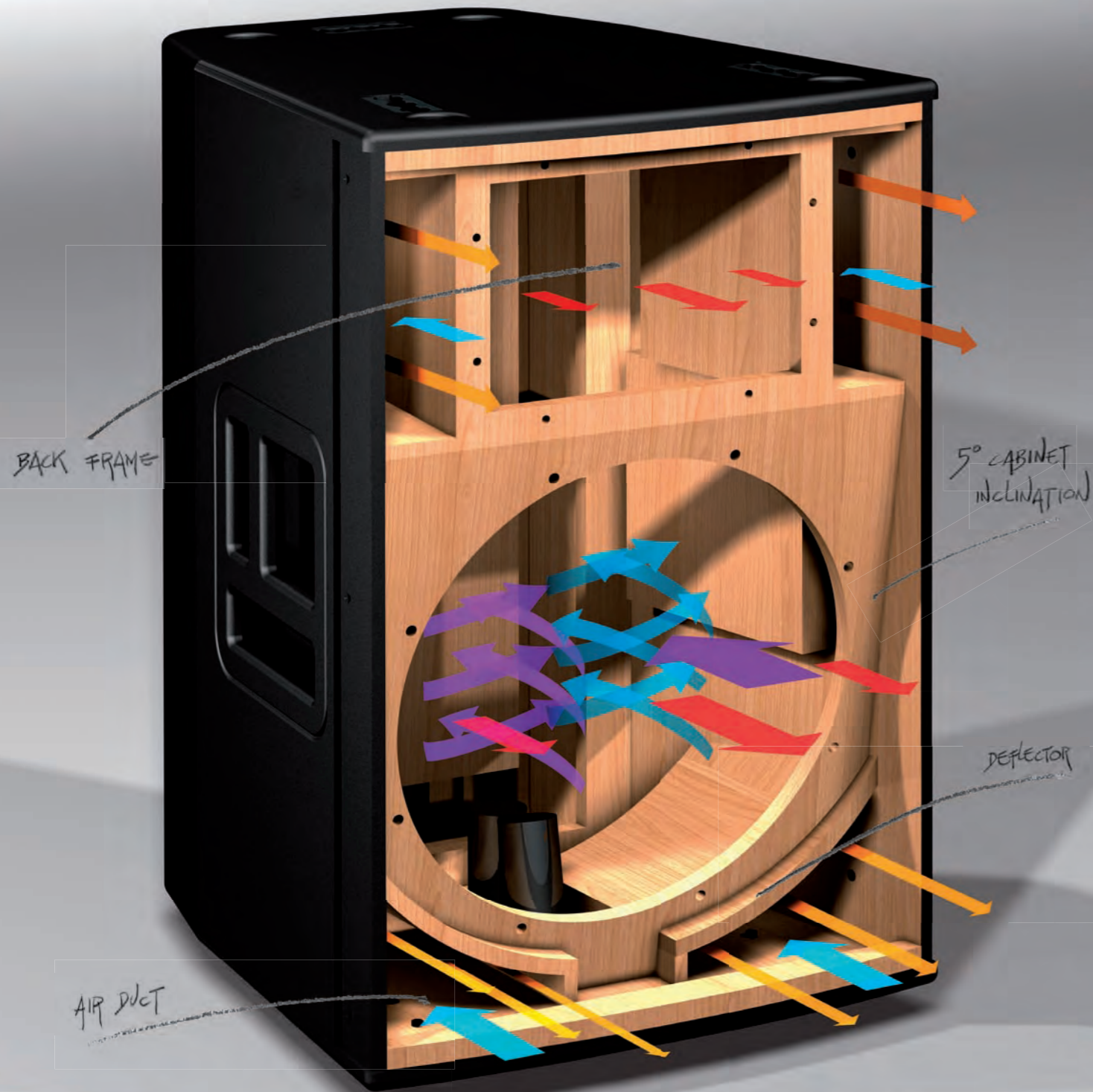

targets

Audio distributors - Rental companies - Show agencies - Event promoters/organizers - Production of musical performances - Owners of public entertainment venues - Private/public corporations or institutions - Musical instrument retailers - Architects/designers - Audio installers/technicians - Portable PA users (bands, musicians & entertainers)

applications

- Concert & touring***
 - small • medium • large scale
- Arrayable FOH enclosures***
- Central clusters, front fill, side fill, delay towers, etc...**
- Open-air events,**
 - public squares, etc...
 - small • medium • large scale
- Portable PA systems**
 - for musicians, bands and entertainers
 - small • medium size
- Stadiums, Sports halls, Arenas**
- Theme parks, Circus shows**
- Theatres, Auditoriums, Music halls**
- Places of worship**
- Fixed installations**
 - small • medium • large size
- Live clubs, Music pubs**
 - and other Live Performance Venues*
 - small • medium • large size
- Dance clubs, night clubs and lounge bars**
 - small • medium • large size
- Multi-purpose venues,**
 - Recreational and cultural structures,
 - Conference centers and Fairs
- Cinemas**
- HO.RE.CA. (Hotel, Restaurant and Café)**
- Corporate A/V events**
- Festivals, Exhibitions, Competitions**
 - and other public events

* XTD1015 + XTDS18

technologies

HDSC™

RODAP™

ESAH flying system

AWSH™

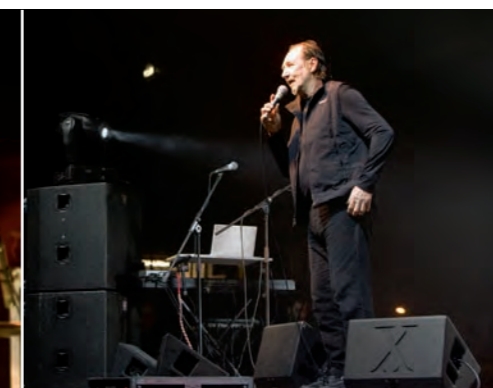
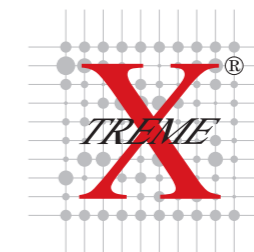

deflector line

loudspeaker systems



The new **Deflector Line** fully encapsulates the ambitious design parameters that the X-Treme engineers defined during the *system design* phase, thanks to the important collaboration with several sound technicians, musicians and mere music lovers, who collaborate with the company's R&D department daily. Above all, the design staff set the target of obtaining a line of products that had to be *light* and *manageable* but, at the same time, had a *reinforced structure*; what is more, they wanted to create speakers that had a chassis in wood, reproduced "*clear*" sound, were totally free from vibrations and able to reach a high level of SPL, while guaranteeing uniform, rich and well balanced

sound in all conditions. Well, the tangible proofs of the conformity of the Deflector Line to such pretentious specifications are clear to any observer even before listening to the various systems and therefore "*liberating*" the surprising power of these speakers - up to 800+800 W RMS for the bi-amplified modules and as much as 1600 W RMS for the self-powered subwoofers. The 15 mm cabinet in Canadian birch plywood, the internal strengthening brackets for the suspension system in 420ML iron alloy, the handy aluminium *flying tracks* positioned on the top and bottom of the speakers, the double grip ergonomic handles, the grid that is "*transparent*" to the emitted sound (in actual fact,

it does not obstruct the holes of the internal sponge) and is fixed to the chassis with threaded counter-sunk screws in the specific bushings sunken into the wood, the neodymium loudspeakers with 4" coil with fiber glass support to cope with even the highest temperatures with continuity and safety, the innovative AWH™ (*Acoustic Wave Shaped Horn*) but, above all, the *curved deflector* with proprietary technology connected to the cabinet (designed to control the air flow both inside and out) take this extraordinary series

of *high-end* audio products to heights that have never been reached before in sound reinforcement for this segment of the market. **All the efforts of the X-Treme developers have led to the creation of a range of products that are certainly of interest to those who work in professional audio appreciate constant technological improvements and want instruments that last much longer than the 10-year guarantee** – the only case in the audio sector – **provided by X-Treme.**



	XTD88	XTD88/A	XTD12	XTD12/A
System configuration	loudspeaker system	active loudspeaker system	loudspeaker system	active loudspeaker system
Power handling RMS	550 W	/	850 W	/
Amplifier RMS	/	500 W - class D digital	/	800 + 800 W - class D digital
Frequency response (-3 dB)	60÷20k Hz	60÷20k Hz	55÷19k Hz	55÷19k Hz
Peak SPL (@1 m)	129 dB	129 dB	133 dB	133 dB
Coverage angle (-6 dB)	90° horizontal, 40° vertical	90° horizontal, 40° vertical	90° horizontal, 50° vertical	90° horizontal, 50° vertical
Nominal impedance	8 Ohm	/	8 Ohm	/
Transducers	LF 2x8" neodymium HF 1x1" mylar	LF 2x8" neodymium HF 1x1" mylar	LF 1x12" neodymium HF 1x1,4" titanium	LF 1x12" neodymium HF 1x1,4" titanium
Input	/	max +10 dBu - XLR	/	max +10 dBu - XLR
DSP on board	/	24 bit/96 kHz (2 preset)	/	24 bit/96 kHz (4 preset)
Input connectors	2 x NL4FC Speakon	/	2 x NL4FC Speakon	/
Cabinet	birch plywood	birch plywood	birch plywood	birch plywood
Dimensions (WxHxD)	270x685x400 mm	270x685x400 mm	410x635x432 mm	410x635x432 mm
Net weight (Kg)	19,5	20	31,5	33



	XTD15	XTD15/A	XTD1015	XTD1015/A
System configuration	loudspeaker system	active loudspeaker system	3-way loudspeaker system	active loudspeaker system
Power handling RMS	750 W	/	1400 W	/
BI-Amplified RMS	/	800 + 800 W - class D digital	/	800 + 800 W - class D digital
Frequency response (-3 dB)	50÷19k Hz	50÷19k Hz	55÷17k Hz	55÷17k Hz
Peak SPL (@1 m)	134 dB	134 dB	138 dB	138 dB
Coverage angle (-6 dB)	90° horizontal, 50° vertical	90° horizontal, 50° vertical	90° horizontal, 50° vertical	90° horizontal, 50° vertical
Nominal impedance	8 Ohm	/	8 (LF), 8 (MF+HF) Ohm	/
Transducers	LF 1x15" neodymium / HF 1x1,4" titanium	LF 1x15" neodymium / HF 1x1,4" titanium	LF 1x15" neodymium MF 1x10" neodymium HF 1x1,4" titanium	LF 1x15" neodymium MF 1x10" neodymium HF 1x1,4" titanium
Input	/	max +10 dBu - XLR	/	max +10 dBu - XLR
DSP on board	/	24 bit/96 kHz (4 preset)	/	24 bit/96 kHz (4 preset)
Input connectors	2 x NL4FC Speakon	/	2 x NL4FC Speakon	/
Cabinet	birch plywood	birch plywood	birch plywood	birch plywood
Dimensions (WxHxD)	451x685x510 mm	451x685x510 mm	451x1050x510 mm	451x1050x510 mm
Net weight (Kg)	36	37,5	49	50,5

deflector line subwoofers



The new model **XTDS15** and **XTDS18** in the Deflector Line cannot compete in efficiency and “punch” with the top of the X-Treme range, represented by the High Power Subwoofer, they perform their task very well and can be successfully, and very effectively, inserted into a professional sound reinforcement system, giving that touch of bass and depth that is needed, nothing more, nothing less. On the other hand the possibility of supplying the 1600 Watt of digital amplification offered by the *self-powered* **XTDS15/A** and **XTDS18/A** models is truly remarkable: with these power reserves, a crystal clear, rich and potentially much more penetrating sound can be obtained from a relatively small unit. In short, perfect sound from perfect subwoofers.

The new model **XTDS15** and **XTDS18** have been both physically and acoustically designed to offer the very best performance – and, therefore, the peak of energy developed – at around 90 Hz: thus, they are very compact and fast subwoofers, designed to obtain a high gain/size ratio. The internal reinforcement cross cages increase resistance to even the most critical and long-term stress endured by the 15 mm Canadian birch plywood cabinet. Each model can be easily stacked either with the same type of elements to create vertical sub clusters, or with the upper modules associated with it: model XTD12 can be paired with the 15” sub and models XTD15 and XTD1015 with the 18” sub. Although the subwoofers



	XTDS15	XTDS15/A	XTDS18	XTDS18/A
System configuration	subwoofer	active subwoofer	subwoofer	active subwoofer
Power handling RMS	1000 W	/	1200 W	/
Amplifier RMS	/	1600 W - class D digital	/	1600 W - class D digital
Frequency response (-3 dB)	30÷200 Hz	30÷200 Hz	25÷150 Hz	25÷150 Hz
Peak SPL (@1 m)	134 dB	134 dB	136 dB	136 dB
Nominal impedance	8 Ohm	/	8 Ohm	/
Transducers	LF 1x15” neodymium	LF 1x15” neodymium	LF 1x18” neodymium	LF 1x18” neodymium
Input	/	max +10 dBu - XLR	/	max +10 dBu - XLR
DSP on board	/	24 bit/96 kHz (4 preset)	/	24 bit/96 kHz (4 preset)
Input connectors	2 x NL4FC Speakon	/	2 x NL4FC Speakon	/
Cabinet	birch plywood	birch plywood	birch plywood	birch plywood
Dimensions (WxHxD)	470x615x560 mm	470x615x560 mm	565x610x650 mm	565x610x650 mm
Net weight (Kg)	30,5	32	35	36,5



controlled air flow technology

All the upper modules of the Deflector Line (except for the “small” 2-way XTD88 model) are provided with a revolutionary *bass reflex* concept. The traditional tubular shape has currently been replaced by a **curved deflector**, a device able to deflect a fluid flow in a certain direction - in this case air - and is firmly anchored to the cabinet right next to the woofer, following the circular shape of this component. If you position yourself in front of a speaker and make a crosswise cutaway with a plane that is perpendicular to the ground, you can easily identify the **profile of the deflector**, which is a *convex-concave* shape (according to convection which foresees first quoting the *intrados*, or the lower surface, and then the *extrados*, or the upper surface) and has a *camber* – defined as the distance between the *wing chord* and the *median line*: it is about the classic “roundedness” of surface of a wing – which is drastically reduced, so as not to unnecessarily obstruct the airflow controlled by the deflector. This solution was achieved by using special fluid dynamic simulations during the design phase, as well as several prototypes that were produced in the laboratory; all this to obtain a long-awaited control of the airflow generated by the inside of the cabinet and the duct. In a non viscous environment and at a sufficient distance from the walls, this airflow is transformed from irregular and vortical, due to the bass reflex “whirlpool”, into a smooth and regular flow. This is also thanks to the intervention of a specific rear frame of no less than 5 cm, and to a 5-degree *tilting* of the plane where the loudspeaker is anchored. As well as being designed for different types of cluster depending on the horn dispersion angles, this *mixed tilting* of the outer walls has been created to cancel out the typical turbulence that usually occurs, in particular on the phase inverter: this involves the minimization of the waves reflected on the woofer, thanks also to the precise alignment of the duct with the cone (the field of tolerance is just a few mm), the complete disappearance of resonance and the cancellation of phases in the points of input and of output, with consequent uniformity and optimization of the acoustic pressure within the cabinet.

DEFLECTOR SHAPES

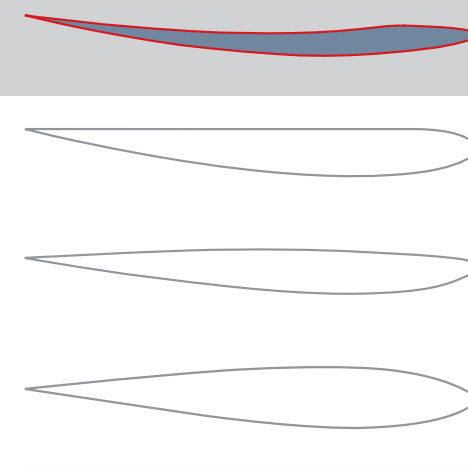

BASIC DEFINITIONS

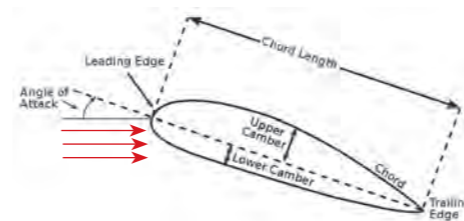

AWSH™

deflector line

The **AWSH™** aluminium horn (*Acoustic Wave Shaped Horn*) has been designed and produced using CAE tools (*Computer Aided Engineering*) for a complete phase alignment of the acoustic wave guide with respect to the woofer; this occurs owing to the nozzle's original geometric configuration and the ingenious fringe that protrudes from the edge of the attachment, ensuring the physical and acoustic alignment of the unit to the front

panel where the loudspeaker is located. The manufacturing process used is *die casting*, that is casting of the molten alloy in a permanent metallic form - *mould or die* - specifically designed for this original piece, according to the specifications provided by the X-Treme engineers. The manufacturing process is performed under pressure, thus permitting the cavity of the mould to be filled very quickly, as well as providing a compensatory supply for solidifying shrinkage; this causes the following effects: perfect and total filling of the mould cavity, giving the piece a fine crystalline structure with no imperfections.

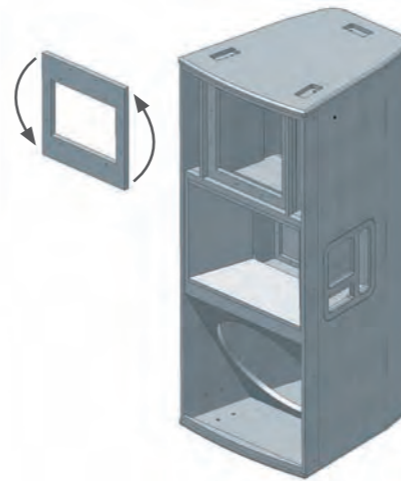

In **XDT88** and **XDT1015** models, as a result of the special anchoring of the AWSH™ in the particular cavity of the speaker, it is possible to *rotate the entire mid-range and tweeter section* (horn+driver+panel) by 90°, thus allowing the same coverage - 90° x 50° - to be maintained, either when the speaker is in a standard or vertical position, or when it is mounted horizontally. By simply unscrewing the 8 screws on the external square flange, it can be rotated without damaging the connection cables or compromising the other internal elements.

going into DETAILS

All the Deflector Line active speakers have a new **digital amplifier** with *switching* power supply and *class D* final stage *on board* that has been designed specifically for this range of products. The distinguishing features of these devices can be summed up in just four simple words: power, efficiency, reliability and lightness. As a matter of fact, the 500 W RMS of mod. XTD88/A - encapsulated in a speaker that is just 27 cm wide and equipped with two 8" components - and no less than 1600 W RMS in the other Deflector Line active models - upper modules and subwoofers - offer the best power/weight ratio available on the global market for audio system electronics. All the amplifiers are equipped with powerful DSP (*Digital Signal Processing*) that is programmed with 2/4 different *presets*, which can be selected by the user via switches on the amplifier panel; they enable the speaker to work at its best according to the application or the musical program to be reproduced.



DEFLECTOR

DEFLECTOR accessories

for SUSPENSION

STD-WALL

Wall bracket for vertical support of a Deflector Line upper module



XT-KITDEF

Flying kit (formed by 3 XT-FTH) for hanging one Deflector Line speaker to a rigging system

DEFLECTOR accessories

OTHERS



XT-ST100

Adjustable-height stand holder for subwoofer-upper module connection



XT-ST125

Adjustable-height three-legged stand for Deflector Line upper modules

high power subwoofers

high power **cardioid** subwoofer

HPS

subwoofers

Rather than developing a product merely to achieve a beautiful design (which often does not guarantee a high quality reproduced sound) or to follow some production efficiency criteria, the X-Treme designers created the **High Power Subwoofers** only taking into account the functionality of these products and their final application: reproducing ultra-low frequencies with unparalleled efficiency and performance in the professional audio sector, in the case of both indoor and outdoor great musical events. Perfect compensation of the masses and volumes, together with reinforcements inside the cabinet, completely eliminates vibrations and maintains the subwoofer characteristics unchanged over time. The SPL peak is reached at 80 Hz, the volume of air displaced by 15" or 18" components and the structural rigidity of the Canadian birch cabinets make the sound reinforcement always deep, round and diffused. To sum up: an incisive and long-lasting "big punch".



XTHPS21

System configuration	infra-bass subwoofer
Power handling RMS	1500 W
Frequency response	25+70 Hz (-3 dB)
Peak SPL (@1 m)	139 dB
Nominal impedance	8 Ohm
Transducers	LF 1x21" neodymium
Input connectors	2 x NL4FC Speakon
Cabinet	birch plywood
Dimensions (WxHxD)	820x600x800 mm
Net weight (Kg)	59,5



XTHPS36

System configuration	double subwoofer
Power handling RMS	2400 W
Frequency response	30+200 Hz (-3 dB)
Peak SPL (@1 m)	143 dB
Nominal impedance	4 Ohm
Transducers	LF 2x18" neodymium
Input connectors	2 x NL4FC Speakon
Cabinet	birch plywood
Dimensions (WxHxD)	1170x580x800 mm
Net weight (Kg)	84
Special version	4+4 Ohm impedance



XTHPS33

System configuration	double subwoofer
Power handling RMS	2200 W
Frequency response	30+150 Hz (-3 dB)
Peak SPL (@1 m)	142 dB
Nominal impedance	4 Ohm
Transducers	LF 1x15" neodymium 1x18" neodymium
Input connectors	2 x NL4FC Speakon
Cabinet	birch plywood
Dimensions (WxHxD)	580x1170x620 mm
Net weight (Kg)	68



XTHPS36/A

System configuration	active double subwoofer
Amplifier RMS	2500 W - class D digital
Frequency response	30+200 Hz (-3 dB)
Peak SPL (@1 m)	143 dB
Power supply	switching technology 115 or 230 V ± 10%
Input	max +10 dBu - XLR
DSP on board	24 bit/96 kHz (2 preset)
PC network (XT-NET)	RJ45 plug - UTP Cat. 5 cable
Cabinet	birch plywood
Dimensions (WxHxD)	1170x580x800 mm
Net weight (Kg)	85,5



HPS

cardioid subwoofer

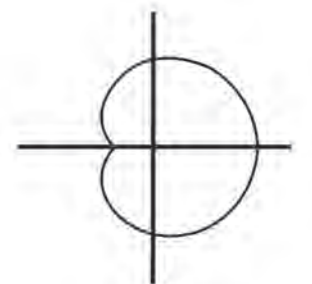

XTCARDIOID

System configuration	cardioid subwoofer
Power handling RMS	front: 2400 W rear: 1200 W
Frequency response	30+150 Hz (-3 dB)
Peak SPL (@1 m)	144 dB
Nominal impedance	front: 4 Ohm rear: 8 Ohm
Transducers	LF 3x18" neodymium
Input connectors	2 x NL4FC Speakon
Cabinet	birch plywood
Dimensions (WxHxD)	1170x580x800 mm
Net weight (Kg)	93,5

The **XTCARDIOID** model should be dealt with separately: in fact, it can be defined as a **controlled directivity "big punch" cardioid subwoofer**. But what do we mean by the term "cardioid"? In geometry the cardioid is a curve (its name refers to its heart-like shape) and, more accurately, an *epicycloid* with just one cusp – see the figure. In the audio sector it means that the polar diagram (that is the angular distribution graph of a speaker system output level at a fixed distance and in the presence of a constantly applied signal) at the working nominal frequency of this subwoofer is of a "heart-shaped" type. This is achieved by controlling the element components with a power amplifier (for example the XTDT6000F model) and a control processor (such as the XTDP26 model) to manage the delay, in order to combine the response of the two front bi-directional 18" loudspeakers with that of the rear omni-directional one. The resulting polar diagram looks like a heart, with a peaked anisotropy in the front direction and a minimum response in the rear direction.



XTHPS21-SK
Wheelboard for XTHPS21
infra-bass subwoofer



XTHPS33-SK
Wheelboard for XTHPS33
double subwoofer



HPS accessories

XTHPS36-SK
XTCARDIOID-SK
Wheelboard for XTHPS36, XTHPS36/A and
XTCARDIOID subwoofers

X-Treme electronics

X-Treme **control electronics** stand out for their extreme *reliability, compactness and functionality*. For the external amplification of its speakers, X-Treme uses the new **Digital Technology Series**, which is produced entirely in *switching* technology and is able to guarantee excellent performance with an extremely light weight. This avant-garde range of amplifiers offers several benefits which place it, without a shadow of a doubt, at the very top of the limited group of ultra-modern electronic instruments for professional audio: the power supply with PFC (*Power Factor Correction*), the forced ventilation that is optimized on those electronic components that are subject to heating and the internal limiter that prevents outgoing signal saturation are just some of the examples of these benefits. The original and innovative concept of X-Treme electronics is also systematically expressed in the design of the various devices's front panels: not decoration but clarity, not superfluity but essentiality. The division of space follows the principle of horizontal balance and the rational positioning of all the elements make the many functions simple and natural. The perfect complement to the audio chain is obtained with the X-Treme **XTDP24** or **XTDP26** processors, which include all the factory presets that are dedicated to the X-Treme speakers, with relative limitation values according to the gains set on the amplifiers; this ensures that the speakers always express their maximum power and energy without risks to the transducers, with functions that can be set and optimized quickly.

“Light electronics!”

The X-Treme **XTDP24** and **XTDP26** digital processors (which have *2 inputs/4 outputs* and *2 inputs/6 outputs*, respectively) are professional management systems for speakers and, as such, can be used for *stereo* configurations up to 2/3 ways or *mono* up to 4/6 ways. Each input has a 6 band parametric equalizer, a high-pass filter and two *shelving* filters and *delay*. Each output can be assigned to the desired input and has a *six* band parametric equalizer, high-pass and low-pass filters, 2 *shelving* filters, *delay*, polarity and limitation threshold. The connection and release times of the limiter are automatically calculated by the processor based on the high-pass cut of the output in use. The XTDP24 and XTDP26 controllers accept incoming signals up to 20 dBu and, for each of the two channels, they use three LEDs to indicate presence, the attainment of 4 dBu and the clip at 20 dBu. Each exit channel has a button for the “*mute*” function and also has two LEDs to indicate,

respectively, the moment in which the signal reaches the limitation threshold and the one in which, on the other hand, it reaches -6 dBu from it. The management of the 45 *memories* and the modification of relative audio parameters can be carried out easily and safely on the panel, thanks to a clear 3.7 inch display and 3 digital knobs. Control via software permits real time modification of several connected processors, with an interface for advanced control, complete with set frequency response graphs. The used colours and the possibility of using the mouse directly on the curves make the processors very easy and quick to use. The *Hardman* high-pass and low-pass filters are particularly avant-garde and enable the user to do very selective cuts (with high slopes) without introducing excessive phase rotation, thus allowing the design of very accurate crossovers. Lastly, the width of the peak bell can be set in Q or octaves, and the delay either in milliseconds or in meters.

controllers
electronics

Plus

Advanced GUI

Network & Remote Control

Hardman Filters

Easy to Use



XTDP24	
Generalities	digital speaker controller
Input channels	2
Output channels	4
PEQ bands	6 for each input and output ch.
PEQ width	0,1 to 5,2 octaves (14,2 to 0,2 Q)
PEQ gains	from -15 to 15 dB
HPF and LPF shapes	1st ord, Bessel 12 to 24 dB/oct, Butterworth 12 to 48 dB/oct, Linkwitz-Riley 12 to 48 dB/oct, Hardman 4th and 8th ord
Delay	0 to 405ms input, 0 to 80ms output*
Dimensions (WxHxD)	483(19")x44(1 RU)x254 mm
Net weight (Kg)	2,2



XTDP26	
Generalities	digital speaker controller
Input channels	2
Output channels	6
PEQ bands	6 for each input and output ch.
PEQ width	0,1 to 5,2 octaves (14,2 to 0,2 Q)
PEQ gains	from -15 to 15 dB
HPF and LPF shapes	1st ord, Bessel 12 to 24 dB/oct, Butterworth 12 to 48 dB/oct, Linkwitz-Riley 12 to 48 dB/oct, Hardman 4th and 8th ord
Delay	0 to 405ms input, 0 to 80ms output*
Dimensions (WxHxD)	483(19")x44(1 RU)x254 mm
Net weight (Kg)	2,5

* Total max **Delay**: 485 ms (distance: 166,5 m)

digital amplifiers

X-TREME

amplifiers
electronics

Plus

Multi-application

High-tech

Lighness

High power & efficiency

The new **Digital Technology Series** amplifiers with *class D* final stage are available in *four* models with a choice of powers and numbers of channels. The **XTDT3200** and **XTDT3800** models have *two* channels and supply power up to 1600W and 1900W, respectively, per channel on 4Ω. The **XTDT4800F** and **XTDT6000F** models, on the other hand, have *four* channels of 1200W and of 1500W, respectively, again on 4Ω. All the amplifiers in the XTDT range have been entirely designed in *switching* technology (both the section of the feeding unit and the power stage) so as to obtain greater power and yield, in a lightweight element, which is inconceivable for traditional configurations. The feeding unit also has

the very useful *active PFC (Power Factor Correction)*, which lowers the angle of phase shift ϕ between the power received from the network - called *apparent* - and the *active* one which represents the effective work, thus reducing the component of *reactive* power that springs from the connection of an inductive load to an AC power supply line. In practical terms, the power consumption is significantly reduced and, in addition, the device performs automatic adaptation of the mains tension of the geographic area of use. These characteristics make the range particularly interesting for the typical demands in the professional audio sector: *power, light weights* and *high performance* (therefore low consumption).

All the **Digital Technology Series** amplifiers are equipped with an integrated controlled system which protects both the amplifier and its load. The signal is constantly monitored with a level control and indication through a LED on the front panel. An in-built limiter protects the loudspeakers from any damage caused by distortion signals. As far as temperature is concerned, the control system maintains the necessary conditions for the correct working of the power components. The output signal control protects the load from high current values or from the presence of potential DC components. *Last but not least*, the modern approach that led to the production of new models is based on *constant gain* (and no longer constant sensitivity), which allows the

presetting of the processor independently of the power of the used amplifiers (in actual fact the value of the limiter for the presets is based on gain). This gain can be set externally from 26 dB to 44 dB with steps of 3 dB. The lower the gain, the lower the background noise, with a high signal required upon input to supply the declared power; the higher the gain selection, the greater the background noise: at 44 dB the noise will have risen by about 15 dB. In other words: in the case of highly professional mixers (which can allow signal distribution even in the order of 20 dBu), the background noise of the speakers can be significantly reduced, thus decreasing the gain of the amplifiers. It is ideal for those applications where silence is essential, e.g. in theatres and conference halls.



only
11 Kg!

XTDT3200

Output Power into 4 Ohm	2 x 1600 W*
Output Power into 8 Ohm	2 x 850 W*
Bridged Output Power into 4 Ohm	1 x 4000 W*
Bridged Output Power into 8 Ohm	1 x 3200 W*
Frequency response (1 W @ 8 Ohm)	20 Hz - 20 kHz +0/-1 dB
THD+N	< 0,1%
Input Selectable Gain	26 - 44 dB, 3 dB step size
Output Circuitry	class D
Power Requirements	95-265 VAC (R-SMPS with PFC)
Dimensions (WxHxD)	483(19")x88(2 RU)x455 mm
Net weight (Kg)	11,5



only
11 Kg!

XTDT3800

Output Power into 4 Ohm	2 x 1900 W*
Output Power into 8 Ohm	2 x 1100 W*
Bridged Output Power into 8 Ohm	1 x 3800 W*
Frequency response (1 W @ 8 Ohm)	20 Hz - 20 kHz +0/-1 dB
THD+N	< 0,1%
Input Selectable Gain	26 - 44 dB, 3 dB step size
Output Circuitry	class D
Power Requirements	95-265 VAC (R-SMPS with PFC)
Dimensions (WxHxD)	483(19")x88(2 RU)x455 mm
Net weight (Kg)	11,5



only
13 Kg!

XTDT4800F

Output Power into 4 Ohm	4 x 1200 W*
Output Power into 8 Ohm	4 x 700 W*
Bridged Output Power into 8 Ohm	2 x 2400 W*
Frequency response (1 W @ 8 Ohm)	20 Hz - 20 kHz +0/-1 dB
THD+N	< 0,1%
Input Selectable Gain	26 - 44 dB, 3 dB step size
Output Circuitry	class D
Power Requirements	95-265 VAC (R-SMPS with PFC)
Dimensions (WxHxD)	483(19")x88(2 RU)x455 mm
Net weight (Kg)	13,5



only
13 Kg!

XTDT6000F

Output Power into 4 Ohm	4 x 1500 W*
Output Power into 8 Ohm	4 x 850 W*
Bridged Output Power into 8 Ohm	2 x 3000 W*
Frequency response (1 W @ 8 Ohm)	20 Hz - 20 kHz +0/-1 dB
THD+N	< 0,1%
Input Selectable Gain	26 - 44 dB, 3 dB step size
Output Circuitry	class D
Power Requirements	95-265 VAC (R-SMPS with PFC)
Dimensions (WxHxD)	483(19")x88(2 RU)x455 mm
Net weight (Kg)	13,5

* EIA 1 kHz - 1% THD - All channels driven @ 230 VAC





one republic founded on music!

One Republic performed, with the support of X-Treme audio systems, at the *Salón de Baile del Círculo de Bellas Artes* in Madrid. This was the only Spanish date of the World Tour that has well and truly established them as a world class band after the success of their album “*Dreaming Out Loud*”, which has topped the charts worldwide. One Republic gave a live performance of those songs that have earned them such a following in the mainstream audience, like *Apologize*, which stayed in the American top five for ten weeks running and was remixed by that great producer - Timbaland and *Stop And Stare*, which once again took them to

the top of the charts in several countries, amongst which were the United States, the UK, Spain and Italy. This was a very intimate and exclusive *secret show*, organized by *MySpace Spain* for its *community*, ready to welcome the band with unique warmth and devotion, thanks also to the unusual layout of the venue, which considerably reduced the traditional distance that usually stands between artists and their audience during large open-air concerts. “*It really was a tall order to amplify an event like that in a historical building and with an audience of more than*

1500 people; the band’s compliments fill us with satisfaction”, declared *Tomàs Bonaut*, General Manager of **EQC Audio**, X-Treme distributor for Spain and Portugal. “*From a technical point of view, we were really impressed to be able to verify ‘hands-on’ the extraordinary horizontal cover of the Mini Line Array X-Treme: even though the public was so close to the stage we didn’t need to add any front fill layout speakers. This characteristic - together with its extreme versatility and compactness - means that this system is really appreciated not only by sound engineers but also by professional riggers*”, ends *Roberto Bonaut*, FOH head technician who coordinated the event.

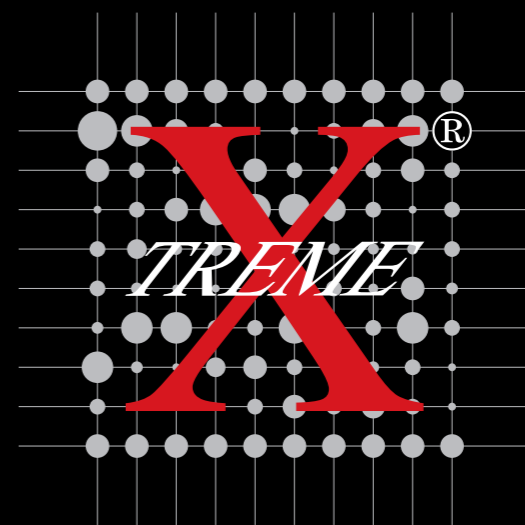

eXplosive sound

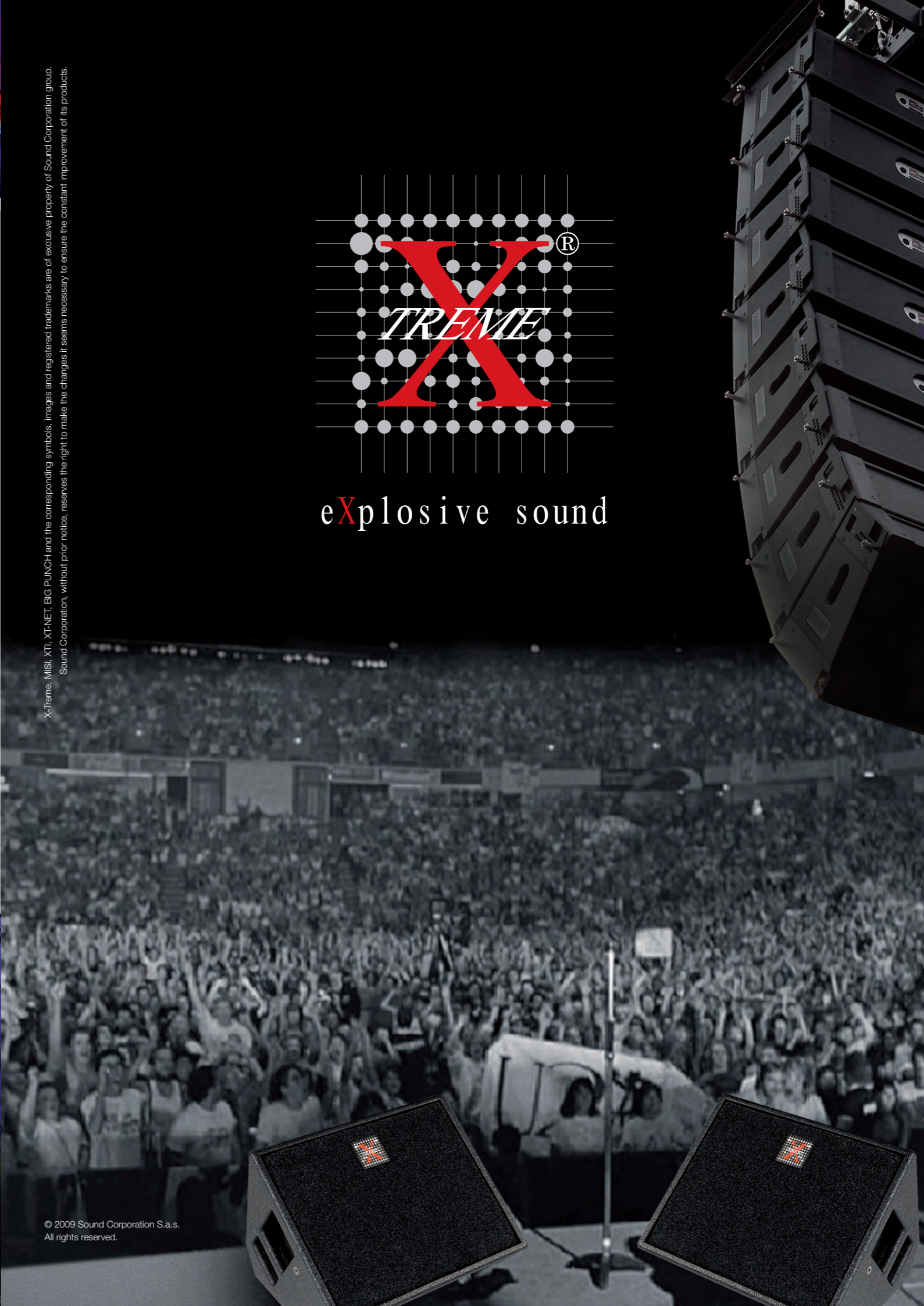

X-Treme, MISI, XTI, XTFNET, BIG PUNCH and the corresponding symbols, images and registered trademarks are of exclusive property of Sound Corporation group. Sound Corporation, without prior notice, reserves the right to make the changes it seems necessary to ensure the constant improvement of its products.

© 2009 Sound Corporation S.a.s. All rights reserved.

ENGLISH



www.x-tremeaudio.com

X-Treme Headquarters:

via Monti Urali, 33
42100 Reggio Emilia - Italy
tel. +39 0522 557735
fax +39 0522 391268
e-mail: info@x-tremeaudio.com
