

PROFESSIONAL STAGE EQUIPMENT

**DH**





**PROFESSIONAL STAGE EQUIPMENT**

## **METAL SYSTEMS**

**4**

MICROPHONE STANDS  
KEYBOARD STANDS  
SPEAKER STANDS  
MUSIC AND GUITAR STANDS

## **PREMADE CABLES**

**14**

ONEHERO SERIES  
GOLD SERIES

## **CONNECTORS**

**23**

ONEHERO SERIES  
PROFESSIONAL ADAPTERS

## **HARD CASES**

**28**

DHCASE SERIES

## **SOFT BAGS**

**32**

ARMOR SERIES - Guitars  
SUN SERIES - Guitars  
MOON SERIES - Keyboards

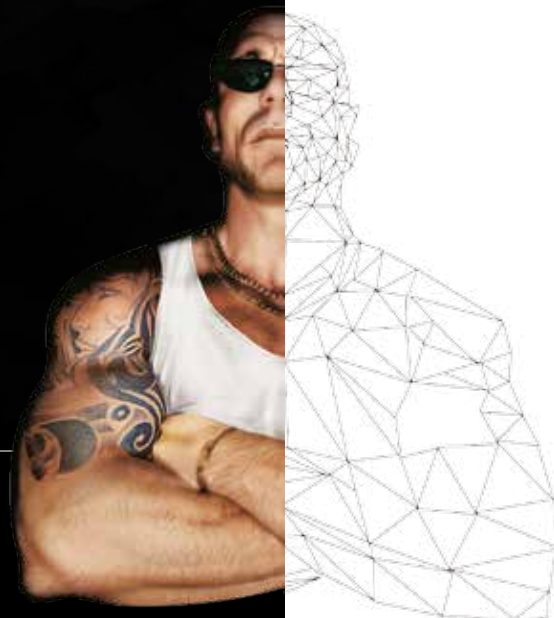



# METAL SYSTEMS



La nuova linea "Metal Systems" di METAL SYSTEMS DH si caratterizza per l'utilizzo di materiali di ultima generazione e l'attenta cura nei particolari, oltre all'indiscusso "Italian style" apprezzato e riconosciuto in tutto il mondo come sinonimo di qualità. Per l'ideazione e progettazione di questi prodotti sono stati interpellati i maggiori professionisti del panorama musicale mondiale. Un team di progettisti è riuscito a dare forma e sostanza a tutte le idee con l'ausilio di una continua ricerca e l'uso di tecnologie ad alto valore aggiunto. L'unione di tutti questi fattori ha permesso di raggiungere dei risultati sorprendenti per soddisfare le molteplici richieste espresse dal mercato nel panorama "on-stage".

*The new DH "Metal Systems" line is characterized by the use of the latest materials and careful attention to details, as well the undisputed "Italian style" appreciated and recognized worldwide for its quality. For the conception and design of these products were polled major professionals in the music world. A team of designers managed to give form and substance to all ideas with the help of continuous research and the use of high value-added technologies. The combination of all these factors has achieved amazing results to meet the multiple needs expressed by the market in the "on-stage" world.*



New concept die-cast aluminum joint



Die-cast aluminum sleeve with "soft-grip"



New concept die-cast aluminum base



## DHPMS40 New

- Asta microfonica professionale a giraffa, dotata di base tripode e snodo superiore in alluminio pressofuso, con tubi in acciaio di elevato spessore per un'ottima stabilità. Lo snodo superiore, di nuova concezione, presenta componenti ergonomici e di alta qualità che ne aumentano il frizionamento e permettono regolazioni accurate. È inoltre provvista di manicotto centrale in alluminio pressofuso ricoperto in morbida gomma "soft-grip" che permette una presa salda per una semplice e sicura regolazione dell'altezza. Dotata di filettatura 3/8" con adattatore a passo 5/8" incluso. Disponibile in nero opaco.

- Professional boom microphone stand, featuring die-cast aluminum heavy duty tripod base and upper joint, with thick steel pipes for optimum stability. The new concept upper joint, presents ergonomic and high-quality components that increase the friction and allow accurate adjustments. It is also provided with a central die-cast aluminum sleeve covered with "soft-grip" rubber which allows a firm grip for a simple and safe height adjustment. Equipped with a 3/8" thread with 5/8" adapter included. Available in matte black.

<b>Height</b>	990 - 1690 mm (38.97" - 66.53")
<b>Base diameter</b>	710 mm (27.95")
<b>Weight</b>	2.90 kg (6.39 lbs)
<b>Boom Length</b>	800 mm (31.49")

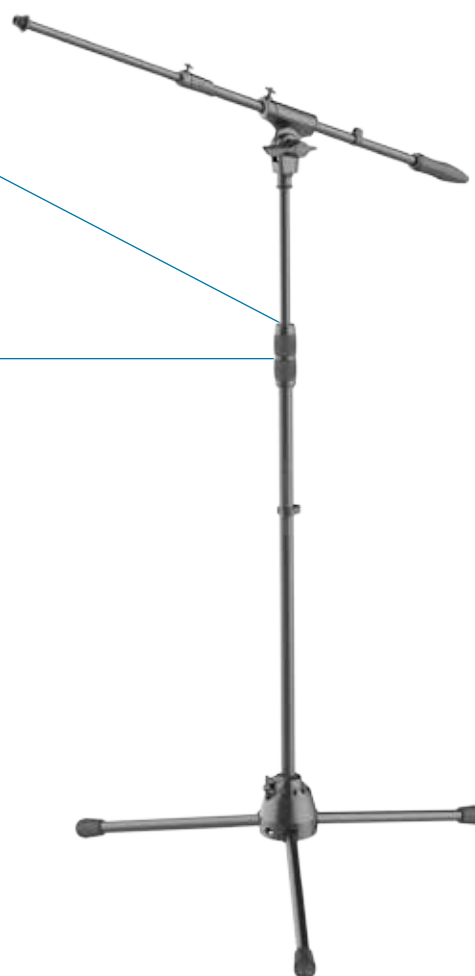
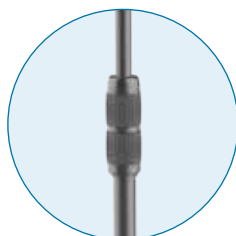

## DHPMS50 New

- Asta microfonica professionale, con le stesse caratteristiche del modello DHPMS40, dotata di giraffa telescopica regolabile. Disponibile in nero opaco (DHPMS50) e cromata (DHPMS55).

- Professional microphone stand, featuring the same characteristics of the DHPMS40 model, with adjustable telescopic boom. Available in matte black (DHPMS50) and chrome finish (DHPMS55).

<b>Height</b>	990 - 1690 mm (38.97" - 66.53")
<b>Base diameter</b>	710 mm (27.95")
<b>Weight</b>	2.90 kg (6.39 lbs)
<b>Boom Length</b>	580 - 910 mm (22.83" - 35.82")



## DHPMS55 New



- Asta microfonica professionale, con le stesse caratteristiche del modello DHPMS40, dotata di giraffa telescopica regolabile. Disponibile in nero opaco (DHPMS50) e cromata (DHPMS55).
- Professional microphone stand, featuring the same characteristics of the DHPMS40 model, with adjustable telescopic boom. Available in matte black (DHPMS50) and chrome finish (DHPMS55).

<b>Height</b>	990 - 1690 mm (38.97" - 66.53")
<b>Base diameter</b>	710 mm (27.95")
<b>Weight</b>	2.90 kg (6.39 lbs)
<b>Boom Length</b>	580 - 910 mm (22.83" - 35.82")



## DHPMS60 New

- Asta microfonica professionale nana, con le stesse caratteristiche del modello DHPMS50, ma con dimensioni ridotte, come da tabella a fondo pagina. Disponibile in nero opaco.
- Professional low profile microphone stand, featuring the same characteristics of the DHPMS50 model, but with reduced dimensions. Available in matte black.

<b>Height</b>	400 - 770 mm (15.74" - 30.31")
<b>Base diameter</b>	600 mm (23.62")
<b>Weight</b>	2.30 kg (5.07 lbs)
<b>Boom Length</b>	580 - 910 mm (22.83" - 35.82")





## DHPMS30 New

• Asta microfonica professionale dritta, dotata di base tripode in alluminio pressofuso, con tubi in acciaio di elevato spessore per un'ottima stabilità. Provvista di manicotto centrale in alluminio pressofuso ricoperto in morbida gomma "soft-grip" che permette una presa salda per una semplice e sicura regolazione dell'altezza. Dotata di filettatura 3/8" con adattatore a passo 5/8" incluso. Disponibile in nero opaco.

• Professional straight microphone stand, featuring die-cast aluminum heavy duty tripod base with thick steel pipes for optimum stability. Provided with a central die-cast aluminum sleeve covered with "soft-grip" rubber which allows a firm grip for a simple and safe height adjustment. Equipped with a 3/8" thread with 5/8" adapter included. Available in matte black.

<b>Height</b>	880 - 1580 mm (34.50" - 62.20")
<b>Base diameter</b>	710 mm (27.95")
<b>Weight</b>	2.30 kg (5.07 lbs)

## DHPMS70 New

• Braccio telescopico professionale, dotato di snodi in alluminio pressofuso, di nuova concezione, che presentano componenti ergonomici e di alta qualità che ne aumentano il frizionamento e permettono regolazioni accurate. Dotata di filettatura 3/8" con adattatore a passo 5/8" incluso. Può essere utilizzato sull'asta dritta DHPMS30 e sui supporti per tastiera serie DHKS10. Disponibile in nero opaco.

• Professional telescopic boom, equipped with new concept die-cast aluminum joints, present ergonomic and high-quality components that increase the friction and allow accurate adjustments. Equipped with a 3/8" thread with pitch 5/8" adapter included. It can be used with the straight DHPMS30 mic stand and with DHKS10 series keyboard stand. Available in matte black.

<b>Weight</b>	0.60 kg (1.32 lbs)
<b>Boom Length</b>	580 - 910 mm (22.83" - 35.82")



## DHPMS10 New

• Asta microfonica professionale dritta con base in acciaio provvista del nuovo sistema ergonomico ONE-HAND che permette una semplice ed accurata regolazione dell'altezza. La base in acciaio a doppio livello, oltre ad offrire una elevata stabilità è dotata di anello circolare in gomma che evita qualsiasi vibrazione/feedback. Disponibile in nero opaco.

• Professional straight microphone stand with steel base provided with new ergonomic ONE-HAND system that allows simple and accurate height regulation. The two layer steel base ensures high stability and features a rubber ring to avoid any vibration/feedback. Available colour: matte black.

<b>Height</b>	1020 - 1680 mm (40.15" - 66.14")
<b>Base diameter</b>	250 mm (9.84")
<b>Weight</b>	4.20 kg (9.26 lbs)



## DHKS40

• Supporto per tastiera a telaio singolo rinforzato, di robusta costruzione. Dotato di tubi di acciaio di alta qualità e giunzioni in alluminio che garantiscono la massima affidabilità. Dotato di un nuovo meccanismo di rilascio di facile utilizzo grazie all'ausilio di una leva che consente una configurazione rapida e una selezione di quattro diverse posizioni d'altezza. E' provvisto inoltre di tappi di gomma autolivellanti che permettono la regolazione su superfici irregolari e assicurano una maggiore stabilità. Fornito smontato per un più facile trasporto. Colori disponibili: nero opaco con inserti in grigio.

• *Single braced heavy duty and sturdy construction keyboard stand. Featuring high-grade steel tubing and die cast aluminium junctions that ensure maximum reliability. Provided with a new easy release mechanism at the touch of a lever that allows a quick set and selection one of four different height positions. Self-levelling rubber caps are supplied for adjustment on uneven surfaces and ensure extra stability. Supplied disassembled for easy shipping. Available colour: matt black with grey insert.*

<b>Tier depth:</b>	380 mm (14.96")
<b>Weight:</b>	4.24 kg (9.34 lbs)
<b>Max loading weight</b>	60 kg (132.27 lbs)
<b>Folded dimension:</b>	1050 x 135 x 510 mm (14.96" x 5.31" x 20.07")

### DHKS40 / DHKS50 TECH INFO

OPENED POSITION	WIDTH	HEIGHT
1	485 mm (19.09")	950 mm (37.40")
2	590 mm (23.22")	880 mm (34.64")
3	700 mm (27.55")	820 mm (32.28")
4	790 mm (31.10")	710 mm (27.95")



## DHKS50

• Supporto per tastiera a telaio doppio, rinforzato, di robusta costruzione, particolarmente adatto per tastiere di grandi dimensioni, digitali e piano. Dotato di tubi di acciaio di alta qualità e giunzioni in alluminio che garantiscono la massima affidabilità. Dotato di un nuovo meccanismo di rilascio di facile utilizzo grazie all'ausilio di una leva che consente una configurazione rapida e una selezione di quattro diverse posizioni d'altezza. E' provvisto inoltre di tappi di gomma autolivellanti che permettono la regolazione su superfici irregolari e assicurano una maggiore stabilità. Fornito smontato per un più facile trasporto. Colori disponibili: nero opaco con inserti in grigio.

• *Double braced heavy duty and sturdy construction keyboard stand particularly suitable for larger keyboards and digital pianos. Featuring high-grade steel tubing and die cast aluminium junctions that ensure maximum reliability. Provided with a new easy release mechanism at the touch of a lever that allows a quick set and selection one of four different height positions. Self-levelling rubber caps are supplied for adjustment on uneven surfaces and ensure extra stability. Supplied disassembled for easy shipping. Available colour: matt black with grey insert.*

<b>Tier depth</b>	380 mm (14.96")
<b>Weight</b>	7.34 kg (16.18 lbs)
<b>Max loading weight</b>	90 kg (198.41 lbs)
<b>Folded dimension</b>	1050 x 135 x 510 mm (14.96" x 5.31" x 20.07")





## DHKS52 New

• Supporto per tastiera a telaio doppio, rinforzato, di robusta costruzione, particolarmente adatto per tastiere di grandi dimensioni, digitali e piano. Dotato di tubi di acciaio di alta qualità e giunzioni in alluminio che garantiscono la massima affidabilità. Dotato di un nuovo meccanismo di rilascio di facile utilizzo grazie all'ausilio di una leva che consente una configurazione rapida e una selezione di quattro diverse posizioni d'altezza. E' provvisto inoltre di tappi di gomma autolivellanti che permettono la regolazione su superfici irregolari e assicurano una maggiore stabilità. Fornito smontato per un più facile trasporto. Colori disponibili: nero opaco con inserti in grigio.

• *Double braced heavy duty and sturdy construction keyboard stand particularly suitable for larger keyboards and digital pianos. Featuring high-grade steel tubing and die cast aluminium junctions that ensure maximum reliability. Provided with a new easy release mechanism at the touch of a lever that allows a quick set and selection one of four different height positions. Self-levelling rubber caps are supplied for adjustment on uneven surfaces and ensure extra stability. Supplied disassembled for easy shipping. Available colour: matt black with grey insert.*

<b>Tier depth</b>	380 mm (14.96")
<b>Weight</b>	10.0 kg (22.40 lbs)
<b>Max loading weight</b>	90 kg (198.41 lbs)
<b>Folded dimension</b>	1050 x 135 x 510 mm (14.96" x 5.31" x 20.07")

DHKS52 TECH INFO			
OPENED POSITION	WIDTH	HEIGHT	2 <sup>nd</sup> TIER HEIGHT
1	485 mm (19.09")	950 mm (37.40")	1227 mm (48.30")
2	590 mm (23.22")	880 mm (34.64")	-
3	700 mm (27.55")	820 mm (32.28")	-
4	790 mm (31.10")	710 mm (27.95")	993 mm (39.09")



## DHKS10BK - DHKS10SL

• Supporto a colonna per tastiere dotato di doppi bracci regolabili in altezza. Realizzato in alluminio estruso e acciaio tubolare, materiali che assicurano la massima affidabilità. I gambi rientrano nella struttura e i bracci si ripiegano per permettere un facile trasporto con la pratica borsa in dotazione.

• *Column style keyboard stand, now with additional 3<sup>rd</sup> leg enhanced stability. Constructed from robust steel tubing and extruded aluminium profile, this roadworthy stand is built with maximum reliability in mind. Other features include double height adjustment arms and legs that retract inside the centre column allowing easy transportation inside the included carrying bag.*

<b>Height</b>	1040 mm (40.94")
<b>Tiers length</b>	lower 440 mm (17.32") – upper 390 mm (15.35")
<b>Weight</b>	7.50 kg (16.53 lbs)
<b>Maximum load</b>	lower tier 25 kg (55.11 lbs) – upper tier 20 kg (44.09 lbs)*
<b>Folded dimensions</b>	1200 mm x 150 mm x 150 mm (47.24" x 5.90" x 5.90")

\* Load capacity is 25 kg lower tier and 20 kg for the upper tier when the legs are levelled and positioned firmly on the surface.



DHPMS70 (Page 7)  
 • Utilizzabile sul DHKS10  
 • Usable on the DHKS10

## DHSS40

• Distanziale professionale regolabile per satellite – subwoofer, realizzato in acciaio tubolare e parti in alluminio. Dotato del sistema di sicurezza con pin automatico e del collaudato dispositivo ad aria "AIR-CUSHIONED" per garantire massima flessibilità, velocità e facilità nelle operazioni di regolazione. Colore nero opaco.

• Professional height adjustable satellite – subwoofer spacer constructed from robust steel tubes and aluminum parts. Equipped with the security system with automatic pin and the well known "AIR-CUSHIONED" system, to ensure maximum flexibility, fast and easy adjustment. Available in matt black.

<b>Adjustable Height:</b>	880 – 1320 mm (34.64" – 51.96")
<b>Weight:</b>	1 kg (2.20 lbs)
<b>Max load capacity:</b>	40 kg (88.18 lbs)
<b>Ø Termination tube:</b>	35 mm (1.37")

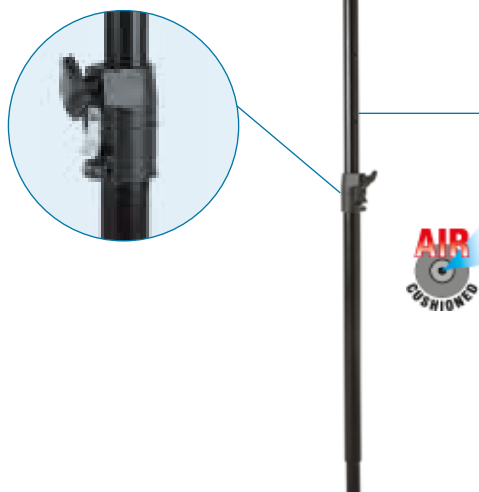

## DHSS50KIT

• Coppia di supporti professionali per diffusori acustici, realizzati in acciaio tubolare e parti in alluminio. Dotati del sistema di sicurezza con pin automatico e del collaudato dispositivo ad aria "AIR-CUSHIONED" per garantire massima flessibilità, velocità e facilità nelle operazioni di regolazione. I supporti sono inoltre muniti di collare in pressofusione per garantire una maggiore tenuta dello snodo dei gambi. Pratica borsa in Nylon 210D per un agevole trasporto. Colore nero opaco.

• Pair of professional loudspeakers stands, made of tubular steel and aluminum parts. Equipped with the security system with automatic pin and the well known "AIR-CUSHIONED" system to ensure maximum flexibility, speed and ease in adjustment operations. The stands are also equipped with casting collar in order to ensure a better tightness of the legs joint. Practical Nylon 210D bag for easy transport included. Available in matt black.

<b>Adjustable Height:</b>	1390 – 2000 mm (54.72 – 78.74")
<b>Weight:</b>	3.90 kg (8.59 lbs)
<b>Max load capacity:</b>	50 kg (110.22 lbs)
<b>Ø Base:</b>	1200 mm (47.24")
<b>Ø Upper tube end:</b>	35 mm (1.37")



## DHSS60 New

• Nuovo e robusto stativo professionale per diffusori acustici, realizzato in acciaio tubolare e parti in alluminio pressofuso. Dotato di un esclusivo meccanismo automatico di elevazione per mezzo di un sistema interno ad aria compressa, che aiuta a sollevare il diffusore acustico senza sforzo. Altezza massima 2000 mm. Finitura nero opaco

• New heavy-duty professional loudspeakers stand, made of tubular steel and die cast aluminum parts. Featuring exclusive automatic elevation mechanism powered by an internal system of compressed air, which helps to raise the loudspeaker without effort. Maximum height 2000 mm. Matt black finishing.

<b>Adjustable Height:</b>	1280 – 2000 mm (78.74 – 78.74")
<b>Weight:</b>	5.00 kg (11.02 lbs)
<b>Max load capacity:</b>	50 kg (110.22 lbs)
<b>Ø Upper tube end:</b>	35 mm (1.37")





## DHSS20

• Stativo professionale per diffusori acustici, realizzato in acciaio tubolare e parti in alluminio pressofuso. Dotato di meccanismo di elevazione con freno meccanico per garantire la massima stabilità al carico e la facilità di montaggio. Altezza massima 2200 mm. Colore nero opaco (tubo superiore zincato).

• Professional height adjustable loudspeaker stand constructed from robust steel tubes and die-cast aluminum. The lifting mechanism features a mechanical brake to guarantee maximum load stability and ease of set up. Maximum height 2200 mm. Matte black colour (upper zinc tube).

<b>Adjustable Height:</b>	1400 - 2200 mm (55.11 - 86.61")
<b>Weight:</b>	8.50 kg (18.73 lbs)
<b>Max load capacity:</b>	60 kg (132.27 lbs)
<b>Ø Base:</b>	1300 mm (51.18")
<b>Ø Upper tube end:</b>	35 mm (1.37")



## DHSS30

Stativo professionale per diffusori acustici / sistemi luce, realizzato in acciaio tubolare e parti in alluminio pressofuso. Dotato di meccanismo di elevazione con freno meccanico per garantire la massima stabilità al carico e la facilità di montaggio. Altezza massima 3200 mm. Colore nero opaco (tubo superiore zincato).

Professional height adjustable loudspeaker / lighting stand constructed from robust steel tubes and die-cast aluminum. The lifting mechanism features a mechanical brake to guarantee maximum load stability and ease of set up. Maximum height 3200 mm. Matte black colour (upper zinc tube).

<b>Adjustable Height:</b>	1850 - 3200 mm (72.83 - 125.98")
<b>Weight:</b>	9.50 kg (20.94 lbs)
<b>Max load capacity:</b>	60 kg (132.27 lbs)
<b>Ø Base:</b>	1300 mm (51.18")
<b>Ø Upper tube end:</b>	35 mm (1.37")



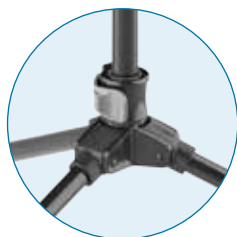
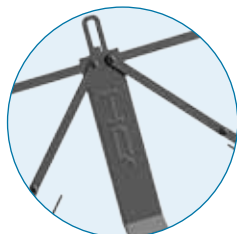

## DHMSS10 *New*

• Nuovo leggìo professionale ultra leggero a tre sezioni completamente pieghevole. Costruito in acciaio, con base dei gambi, snodi intermedi e blocco superiore in alluminio pressofuso, che garantiscono un'elevata stabilità. Tutte le parti interne di scorrimento sono realizzate in nylon di alta qualità che permettono regolazioni semplici ed accurate. Fornito di pratica borsa in nylon per un agevole trasporto. Colore nero.

• New ultra-light professional music stand with three fully collapsible sections. Built in steel, with TRIPOD base, intermediate joints and upper block in die-cast aluminum, which guarantee a high stability. All the inner sliding parts are made of high quality nylon that allow simple and accurate adjustments. Supplied with nylon carrying bag included for easy transport. Black colour.

<b>Adjustable height</b>	680 - 1250 mm (26.77" - 49.21")
<b>Weight</b>	1.60 Kg (3.52 lbs)
<b>Ø Base</b>	680 mm (26.77")
<b>Music sheet dimensions</b>	W 440 x H 240 mm (17.32" - 9.44")

## DHMSS30 *New*

Nuovo leggìo professionale con tavola appoggia spartiti regolabile e base tripoide. Progettato per sostenere carichi notevoli, è dotato di tutti gli snodi realizzati in alluminio pressofuso con parti di scorrimento in nylon, che oltre a garantire regolazioni precise e veloci ne aumentano la stabilità e la durezza nel tempo. Il manicotto centrale, anche esso in alluminio, è ricoperto in morbida e resistente gomma "soft-grip" per una presa salda e sicura. Fornito di pratica borsa in nylon per un agevole trasporto. Disponibile in nero opaco.

*New professional music stand with adjustable metal upper plate and tripod base. Designed to support heavy weight, it is equipped with all die cast aluminum joints with inner nylon parts, which in addition to ensuring precise and quick adjustments, will increase the stability and durability over time. The central sleeve, also made of die cast aluminum, is covered with "soft-grip" durable rubber for a firm and secure grip. Supplied with nylon carrying bag for easy transport. Available in matt black.*

<b>Adjustable height</b>	780 - 1250 mm (30.70" - 49.21")
<b>Weight</b>	2.60 Kg (5.73 lbs)
<b>Ø Base</b>	600 mm (23.62")
<b>Music sheet dimensions</b>	W 500 x H 340 mm (19.68" - 13.38")





## DHMS75

- Leggio professionale per spartiti, dotato del nuovo sistema "one hand" per una rapida e facile regolazione dell' altezza. Provvisto di base triangolare in acciaio per la massima stabilità. Colori disponibili: nero opaco.
- Professional sheet music stand with one hand quick release adjustment system that enables smooth. Heavy triangular cast iron base for maximum stability. Available color: matt black with grey insert.

<b>Adjustable height</b>	1060 - 1600 mm (41.73" - 62.99")
<b>Weight</b>	2.720 Kg (5.99 lbs)
<b>Ø Base</b>	500 mm (19.68")
<b>Music sheet dimensions</b>	W 510 x H 330 mm (20.07" - 12.99")

## DHPGS10 New

- Nuova supporto universale da terra per chitarra, realizzato in acciaio e alluminio. Regolabile in altezza per mezzo del manicotto in alluminio pressofuso ricoperto in gomma "soft-grip". Dotato del sistema di chiusura AUTO-LOCK, che permette il blocco automatico della chitarra semplicemente appoggiandola sul gancio predisposto. Tutte le parti a contatto con il prodotto sono rivestite in morbida gomma ed EVA per proteggere la finitura dello strumento. Completamente ripiegabile per un facile trasporto. Colore nero opaco.

- New universal floor standing stand for guitar, made of steel and aluminum. Adjustable height by means of the "soft-grip" rubber covered die-cast aluminum clutch. Equipped with the AUTO-LOCK closing system, which allows automatic locking of the guitar simply resting it on the dedicated hook. All contact parts are covered with soft rubber and EVA to protect the instrument's finish. Fully foldable for easy transport. Matt black color.

<b>Height</b>	670 - 1290 mm (26.37" - 50.78")
<b>Base diameter</b>	600 mm (23.6")
<b>Net weight</b>	1.45 Kg (3.19 lbs)
<b>Maximum loading weight</b>	15 Kg (33.07 lbs)

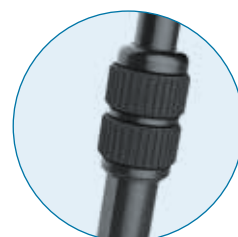



# ONEHERO

ONEHERO è una nuova serie di cavi assemblati e connettori dal design unico ed esclusivo, frutto della ricerca dell'R&D di PROEL che ancora una volta, ha scelto di investire risorse nella progettazione di strumenti innovativi e professionali dedicati alle crescenti richieste del mercato. I cavi assemblati si distinguono per i materiali utilizzati, di ultima generazione ed altissima qualità come rame rosso OHFC (Oxygen Free High Conductivity) lavorato in assenza di ossigeno, che migliora sensibilmente il trasferimento elettrico del segnale, rendendolo più trasparente, puro, limpido, fluido e dinamico.

*ONEHERO is a new series of premade cables and connectors with a unique and exclusive design, the result of PROEL R & D that once again, chose to invest resources in the design of innovative and professional tools dedicated to the growing market demands. The premed cables are distinguished by the materials used, the latest generation and very high quality as red copper OHFC (Oxygen Free High Conductivity) worked in the absence of oxygen, which significantly improves the electric signal transfer, making it more transparent, pure, clear, fluid and dynamic.*

## PREMADE CABLES

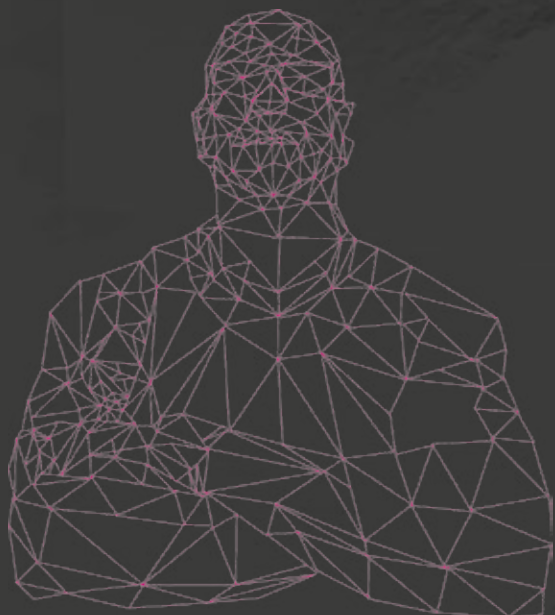



## DHS100 New

### INSTRUMENT CABLE

Ø 6.3 mm MONO JACK PLUG – Ø 6.3 mm MONO JACK PLUG

- Guaina esterna: Ø 7.0 mm PVC ad alta flessibilità
- Conduttore: rame rosso 1x0,50 mm<sup>2</sup>
- 1° schermo: PVC DH ad alta conduttività
- 2° schermo: a treccia di rame stagnato - 128x0,10 mm
- Overall jacket: Ø 7.0 mm high grade flexible PVC
- Conductor: 1x0,50 mm<sup>2</sup> bare copper
- 1<sup>st</sup> shield: DH high conductivity PVC
- 2<sup>nd</sup> shield: dense braided tinned copper wire - 128x0,10 mm

CODE	LENGTH
DHS100LU1	1 mt (3,28 ft)
DHS100LU2	2 mt (6,56 ft)
DHS100LU3	3 mt (9,84 ft)
DHS100LU5	5 mt (16,40 ft)
DHS100LU6	6 mt (19,69 ft)
DHS100LU10	10 mt (32,81 ft)



## DHS120 New

### INSTRUMENT CABLE

Ø 6.3 mm MONO JACK PLUG – Ø 6.3 mm RIGHT ANGLE MONO JACK PLUG

- Guaina esterna: Ø 7.0 mm PVC ad alta flessibilità
- Conduttore: 1x0,50 mm<sup>2</sup>
- 1° schermo: PVC DH ad alta conduttività
- 2° schermo: a treccia di rame stagnato - 128x0,10 mm
- Overall jacket: Ø 7.0 mm high grade flexible PVC
- Conductor: 1x0,50 mm<sup>2</sup>
- 1<sup>st</sup> shield: DH high conductivity PVC
- 2<sup>nd</sup> shield: dense braided tinned copper wire - 128x0,10 mm

CODE	LENGTH
DHS120LU3	3 mt (9,84 ft)
DHS120LU5	5 mt (16,40 ft)
DHS120LU6	6 mt (19,69 ft)



## DHS200 New

### UNBALANCED CABLE

Ø 6.3 mm MONO JACK PLUG – 3P FEMALE XLR

- Guaina esterna: Ø 7.0 mm PVC ad alta flessibilità
- Conduttori: rame rosso 2x0,34 mm<sup>2</sup>
- 1° schermo: LLPDE
- 2° schermo: a treccia di rame stagnato - 128x0,10 mm
- Overall jacket: Ø 7.0 mm high grade flexible PVC
- Conductors: 2x0,34 mm<sup>2</sup> bare copper
- 1<sup>st</sup> shield: LLPDE
- 2<sup>nd</sup> shield: dense braided tinned copper wire - 128x0,10 mm

CODE	LENGTH
DHS200LU3	3 mt (9,84 ft)
DHS200LU5	5 mt (16,40 ft)
DHS200LU10	10 mt (32,81 ft)



## DHS220 New

### UNBALANCED CABLE

Ø 6.3 mm MONO JACK PLUG – 3P MALE XLR

- Guaina esterna: Ø 7.0 mm PVC ad alta flessibilità
- Conduttori: rame rosso 2x0,34 mm<sup>2</sup>
- 1° schermo: LLPDE
- 2° schermo: a treccia di rame stagnato - 128x0,10 mm
- Overall jacket: Ø 7.0 mm high grade flexible PVC
- Conductors: 2x0,34 mm<sup>2</sup> bare copper
- 1<sup>st</sup> shield: LLPDE
- 2<sup>nd</sup> shield: dense braided tinned copper wire - 128x0,10 mm

CODE	LENGTH
DHS220LU1	1 mt (3,28 ft)
DHS220LU3	3 mt (9,84 ft)
DHS220LU5	5 mt (16,40 ft)
DHS220LU10	10 mt (32,81 ft)



## DHS140 New

### BALANCED CABLE

Ø 6.3 mm STEREO JACK PLUG – Ø 6.3 mm STEREO JACK PLUG

- Guaina esterna: Ø 7.0 mm PVC ad alta flessibilità
- Conduttori: rame rosso 2x0,34 mm<sup>2</sup>
- 1° schermo: PVC DH
- 2° schermo: a treccia di rame stagnato - 128x0,10 mm
- Overall jacket: Ø 7.0 mm high grade flexible PVC
- Conductors: 2x0,34 mm<sup>2</sup> bare copper
- 1<sup>st</sup> shield: DH high grade PVC
- 2<sup>nd</sup> shield: dense braided tinned copper wire - 128x0,10 mm

CODE	LENGTH
DHS140LU1	1 mt (3,28 ft)
DHS140LU2	2 mt (6,56 ft)
DHS140LU3	3 mt (9,84 ft)
DHS140LU5	5 mt (16,40 ft)



## DHS210 New

### BALANCED CABLE

Ø 6.3 mm STEREO JACK PLUG – 3P FEMALE XLR

- Guaina esterna: Ø 7.0 mm PVC ad alta flessibilità
- Conduttori: rame rosso 2x0,34 mm<sup>2</sup>
- 1° schermo: PVC DH
- 2° schermo: a treccia di rame stagnato - 128x0,10 mm
- Overall jacket: Ø 7.0 mm high grade flexible PVC
- Conductors: 2x0,34 mm<sup>2</sup> bare copper
- 1<sup>st</sup> shield: DH high grade PVC
- 2<sup>nd</sup> shield: dense braided tinned copper wire - 128x0,10 mm

CODE	LENGTH
DHS210LU1	1 mt (3,28 ft)
DHS210LU2	2 mt (6,56 ft)
DHS210LU3	3 mt (9,84 ft)
DHS210LU5	5 mt (16,40 ft)



## DHS230 New

### BALANCED CABLE

Ø 6.3 mm STEREO JACK PLUG – 3P MALE XLR

- Guaina esterna: Ø 7.0 mm PVC ad alta flessibilità
- Conduttori: rame rosso 2x0,34 mm<sup>2</sup>
- 1° schermo: PVC DH
- 2° schermo: a treccia di rame stagnato – 128x0,10 mm
- Overall jacket: Ø 7.0 mm high grade flexible PVC
- Conductors: 2x0,34 mm<sup>2</sup> bare copper
- 1<sup>st</sup> shield: DH high grade PVC
- 2<sup>nd</sup> shield: dense braided tinned copper wire – 128x0,10 mm

CODE	LENGTH
DHS230LU05	0,5mt (1,64 ft)
DHS230LU1	1 mt (3,28 ft)
DHS230LU2	2 mt (6,56 ft)
DHS230LU3	3 mt (9,84 ft)
DHS230LU5	5 mt (16,40 ft)
DHS230LU10	10 mt (32,81 ft)



## DHS240 New

### BALANCED CABLE

3P FEMALE XLR – 3P MALE XLR

- Guaina esterna: Ø 7.0 mm PVC ad alta flessibilità
- Conduttori: rame rosso 2x0,34 mm<sup>2</sup>
- 1° schermo: PVC DH
- 2° schermo: a treccia di rame stagnato – 128x0,10 mm
- Overall jacket: Ø 7.0 mm high grade flexible PVC
- Conductors: 2x0,34 mm<sup>2</sup> bare copper
- 1<sup>st</sup> shield: DH high grade PVC
- 2<sup>nd</sup> shield: dense braided tinned copper wire – 128x0,10 mm

CODE	LENGTH
DHS240LU05	0,5mt (1,64 ft)
DHS240LU1	1 mt (3,28 ft)
DHS240LU2	2 mt (6,56 ft)
DHS240LU3	3 mt (9,84 ft)
DHS240LU5	5 mt (16,40 ft)
DHS240LU6	6 mt (19,69 ft)
DHS230LU10	10 mt (32,81 ft)



## DHS505 New

### ADAPTER CABLE

2 x RCA – 2 x RCA

- Guaina esterna: 2xØ 5.0 mm PVC ad alta flessibilità
- Conduttori: rame rosso 2x0,22 mm<sup>2</sup>
- 1° schermo: LLDPE
- 2° schermo: a spirale di rame rosso
- Overall jacket: 2xØ 5.0 mm high grade flexible PVC
- Conductors: 2x0,22 mm<sup>2</sup> bare copper
- 1<sup>st</sup> shield: LLDPE
- 2<sup>nd</sup> shield: dense spiral bare copper wire

CODE	LENGTH
DHS505LU18	1,8mt (5,91 ft)
DHS505LU3	3 mt (9,84 ft)



## DHS520 New

### INSERT CABLE

3,5 STEREO JACK PLUG – 2 x RCA

- Guaina esterna: Ø 6.5 mm – Ø 5.0 mm PVC ad alta flessibilità
- Conduttori: rame rosso 0,22 mm<sup>2</sup>
- 1° schermo: LLDPE
- 2° schermo: a spirale di rame rosso
- Overall jacket: Ø 6.5 mm – Ø 5.0 mm high grade flexible PVC
- Conductors: 0,22 mm<sup>2</sup> bare copper
- 1<sup>st</sup> shield: LLDPE
- 2<sup>nd</sup> shield: dense spiral bare copper wire

CODE	LENGTH
DHS520LU18	1,8mt (5,91 ft)
DHS520LU3	3 mt (9,84 ft)
DHS520LU5	5 mt (16,40 ft)



## DHS530 New

### INSERT CABLE

6,3 STEREO JACK PLUG – 2 x RCA

- Guaina esterna: Ø 6.5 mm – Ø 5.0 mm PVC ad alta flessibilità
- Conduttori: rame rosso 0,22 mm<sup>2</sup>
- 1° schermo: LLDPE
- 2° schermo: a spirale di rame rosso
- Overall jacket: Ø 6.5 mm – Ø 5.0 mm high grade flexible PVC
- Conductors: 0,22 mm<sup>2</sup> bare copper
- 1<sup>st</sup> shield: LLDPE
- 2<sup>nd</sup> shield: dense spiral bare copper wire

CODE	LENGTH
DHS530LU18	1,8mt (5,91 ft)
DHS530LU3	3 mt (9,84 ft)



## DHS535 New

### ADAPTER CABLE

2 x 6,3 MONO JACK PLUG – 2 x RCA

- Guaina esterna: 2xØ 5.0 mm PVC ad alta flessibilità
- Conduttori: rame rosso 2x0,22 mm<sup>2</sup>
- 1° schermo: LLDPE
- 2° schermo: a spirale di rame rosso
- Overall jacket: 2xØ 5.0 mm high grade flexible PVC
- Conductors: 2x0,22 mm<sup>2</sup> bare copper
- 1<sup>st</sup> shield: LLDPE
- 2<sup>nd</sup> shield: dense spiral bare copper wire

CODE	LENGTH
DHS535LU18	1,8mt (5,91 ft)
DHS535LU3	3 mt (9,84 ft)
DHS535LU5	5 mt (16,40 ft)



## DHS540 New

### INSERT CABLE

6,3 STEREO JACK PLUG - 2 x 6,3 MONO JACK PLUG

- Guaina esterna: Ø 6.5 mm - Ø 5.0 mm PVC ad alta flessibilità
- Conduttori: rame rosso 0,22 mm<sup>2</sup>
- 1° schermo: LLDPE
- 2° schermo: a spirale di rame rosso
- Overall jacket: Ø 6.5 mm - Ø 5.0 mm high grade flexible PVC
- Conductors: 0,22 mm<sup>2</sup> bare copper
- 1<sup>st</sup> shield: LLDPE
- 2<sup>nd</sup> shield: dense spiral bare copper wire

CODE	LENGTH
DHS540LU18	1,8mt (5,91 ft)
DHS540LU3	3 mt (9,84 ft)
DHS540LU5	5 mt (16,40 ft)



## DHS545 New

### INSERT CABLE

3,5 STEREO JACK PLUG - 2 x 6,3 MONO JACK PLUG

- Guaina esterna: Ø 6.5 mm - Ø 5.0 mm PVC ad alta flessibilità
- Conduttori: rame rosso 0,22 mm<sup>2</sup>
- 1° schermo: LLDPE
- 2° schermo: a spirale di rame rosso
- Overall jacket: Ø 6.5 mm - Ø 5.0 mm high grade flexible PVC
- Conductors: 0,22 mm<sup>2</sup> bare copper
- 1<sup>st</sup> shield: LLDPE
- 2<sup>nd</sup> shield: dense spiral bare copper wire

CODE	LENGTH
DHS545LU18	1,8mt (5,91 ft)
DHS545LU3	3 mt (9,84 ft)
DHS545LU5	5 mt (16,40 ft)



## DHS550 New

### BALANCED CABLE

3,5 STEREO JACK PLUG - 3,5 STEREO JACK PLUG

- Guaina esterna: Ø 5.0 mm PVC ad alta flessibilità
- Conduttori: rame rosso 2x0,22 mm<sup>2</sup>
- 1° schermo: LLDPE
- 2° schermo: a spirale di rame rosso
- Overall jacket: Ø 5.0 mm high grade flexible PVC
- Conductors: 2x0,22 mm<sup>2</sup> bare copper
- 1<sup>st</sup> shield: LLDPE
- 2<sup>nd</sup> shield: dense spiral bare copper wire

CODE	LENGTH
DHS550LU18	1,8mt (5,91 ft)
DHS550LU3	3 mt (9,84 ft)



## DHS560 New

### ADAPTER BALANCED CABLE

3,5 STEREO JACK PLUG - 6,3 STEREO JACK PLUG

- Guaina esterna: Ø 5.0 mm PVC ad alta flessibilità
- Conduttori: rame rosso 2x0,22 mm<sup>2</sup>
- 1° schermo: LLDPE
- 2° schermo: a spirale di rame rosso
- Overall jacket: Ø 5.0 mm high grade flexible PVC
- Conductors: 2x0,22 mm<sup>2</sup> bare copper
- 1<sup>st</sup> shield: LLDPE
- 2<sup>nd</sup> shield: dense spiral bare copper wire

CODE	LENGTH
DHS560LU18	1,8mt (5,91 ft)
DHS560LU3	3 mt (9,84 ft)



## DHS595 New

### STEREO CABLE

3,5 STEREO JACK PLUG - 2 x 3P MALE XLR

- Guaina esterna: Ø 6.5 mm - Ø 5.0 mm PVC ad alta flessibilità
- Conduttori: rame rosso 0,22 mm<sup>2</sup>
- 1° schermo: LLDPE
- 2° schermo: a spirale di rame rosso
- Overall jacket: Ø 6.5 mm - Ø 5.0 mm high grade flexible PVC
- Conductors: 0,22 mm<sup>2</sup> bare copper
- 1<sup>st</sup> shield: LLDPE
- 2<sup>nd</sup> shield: dense spiral bare copper wire

CODE	LENGTH
DHS595LU18	1,8mt (5,91 ft)
DHS595LU3	3 mt (9,84 ft)
DHS595LU5	5 mt (16,40 ft)



## DHS600 New

### INSTRUMENT CABLE

2 X Ø 6.3 mm RIGHT ANGLE MONO JACK PLUG

- Guaina esterna: Ø 7.0 mm PVC ad alta flessibilità
- Conduttore: 1x0,50 mm<sup>2</sup>
- 1° schermo: PVC DH ad alta conduttività
- 2° schermo: a treccia di rame stagnato - 128x0,10 mm
- Overall jacket: Ø 7.0 mm high grade flexible PVC
- Conductor: 1x0,50 mm<sup>2</sup>
- 1<sup>st</sup> shield: DH high conductivity PVC
- 2<sup>nd</sup> shield: dense braided tinned copper wire - 128x0,10 mm

CODE	LENGTH
DHS600LU015	0,15 mt (5,90 ft)
DHS600LU03	0,3 mt (11,81 ft)



# GOLD

La linea Gold della serie DH, si è sempre posizionata ai vertici del mercato in quanto a caratteristiche tecniche, affidabilità, e durevolezza nel tempo. Con la tradizione di PROEL e gli elevati standard di efficienza e di qualità dei prodotti, abbiamo raggiunto obiettivi importanti in fatto di competitività e il rispetto da parte di professionisti del settore. Le peculiarità fondamentali che contraddistinguono questa serie e che hanno permesso di ottenere elevatissime performance sono il controllo costante della qualità, la scelta dei materiali e la loro lavorazione. Per i cavi DHG PROEL ha scelto materiali indiscutibili, geometrie particolari, cura del design e controllo costante della qualità riuscendo a rispettare la fedeltà e a garantire l'integrità del segnale.

*The well-known DH Gold series, has always been at the top of the market due to its technical features, reaching a considerable competitiveness and the esteem from the professionals of the field. The tradition of Proel together with constant quality control, choice of materials and production methods are the key features that identify the series and that have led it to very high performances.*

*PROEL has chosen for its DHG cables a selection of pure materials, distinctive patterns as well as unprecedented product design's accuracy and constant quality monitoring, all elements that have allowed us to follow closely the signal integrity.*

## PREMADE CABLES

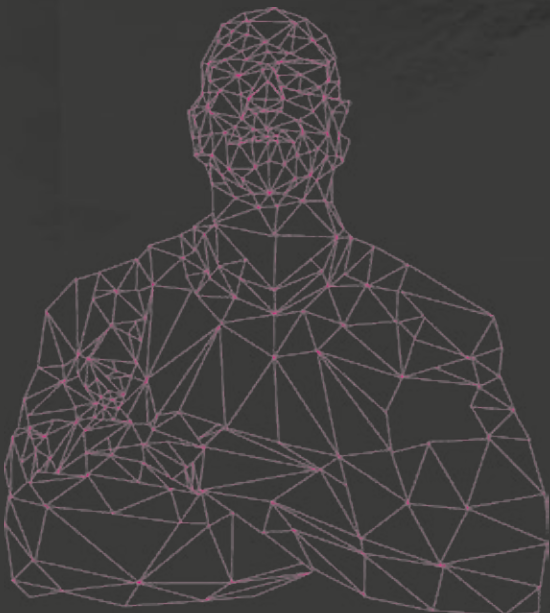

### PATENTED SPRING RETENTION SYSTEMS







## DHG100

### INSTRUMENT CABLE

Ø 6.3 mm MONO JACK PLUG – Ø 6.3 mm MONO JACK PLUG

- Guaina esterna: Ø 6.5 mm PVC ad alta flessibilità
- 1° schermo: PVC DH ad alta conduttività
- 2° schermo: a treccia di rame rosso
- Overall jacket: Ø 6.5 mm high grade flexible PVC
- 1st shield: DH high conductivity PVC
- 2nd shield: dense braided red copper wire

CODE	LENGTH
DHG100LU05	0,5 mt (1,64 ft)
DHG100LU1	1 mt (3,28 ft)
DHG100LU2	2 mt (6,56 ft)
DHG100LU3	3 mt (9,84 ft)
DHG100LU5	5 mt (16,40 ft)
DHG100LU6	6 mt (19,69 ft)
DHG100LU10	10 mt (32,81 ft)



## DHG120

### INSTRUMENT CABLE

Ø 6.3 mm MONO JACK PLUG – Ø 6.3 mm RIGHT ANGLE MONO JACK PLUG

- Guaina esterna: Ø 6.5 mm PVC ad alta flessibilità
- 1° schermo: PVC DH ad alta conduttività
- 2° schermo: a treccia di rame rosso
- Overall jacket: Ø 6.5 mm high grade flexible PVC
- 1st shield: DH high conductivity PVC
- 2nd shield: dense braided red copper wire

CODE	LENGTH
DHG120LU3	3 mt (9,84 ft)
DHG120LU5	5 mt (16,40 ft)
DHG120LU6	6 mt (19,69 ft)



## DHG200

### UNBALANCED CABLE

Ø 6.3 mm MONO JACK PLUG – 3P FEMALE XLR

- Guaina esterna: Ø 6.5 mm PVC ad alta flessibilità
- 1° schermo: PVC DH
- 2° schermo: a treccia di rame stagnato
- Overall jacket: Ø 6.5 mm high grade flexible PVC
- 1st shield: DH high grade PVC
- 2nd shield: dense braided tinned copper wire

CODE	LENGTH
DHG200LU3	3 mt (9,84 ft)
DHG200LU5	5 mt (16,40 ft)
DHG200LU10	10 mt (32,81 ft)



## DHG220

### UNBALANCED CABLE

Ø 6.3 mm MONO JACK PLUG – 3P MALE XLR

- Guaina esterna: Ø 6.5 mm PVC ad alta flessibilità
- 1° schermo: PVC DH
- 2° schermo: a treccia di rame stagnato
- Overall jacket: Ø 6.5 mm high grade flexible PVC
- 1st shield: DH high grade PVC
- 2nd shield: dense braided tinned copper wire

CODE	LENGTH
DHG220LU1	1 mt (3,28 ft)
DHG220LU3	3 mt (9,84 ft)
DHG220LU5	5 mt (16,40 ft)
DHG220LU10	10 mt (32,81 ft)



## DHG140

### BALANCED CABLE

Ø 6.3 mm STEREO JACK PLUG – Ø 6.3 mm STEREO JACK PLUG

- Guaina esterna: Ø 6.5 mm PVC ad alta flessibilità
- 1° schermo: PVC DH
- 2° schermo: a treccia di rame stagnato
- Overall jacket: Ø 6.5 mm high grade flexible PVC
- 1st shield: DH high grade PVC
- 2nd shield: dense braided tinned copper wire

CODE	LENGTH
DHG140LU1	1 mt (3,28 ft)
DHG140LU2	2 mt (6,56 ft)
DHG140LU3	3 mt (9,84 ft)
DHG140LU5	5 mt (16,40 ft)



## DHG210

### BALANCED CABLE

Ø 6.3 mm STEREO JACK PLUG – 3P FEMALE XLR

- Guaina esterna: Ø 6.5 mm PVC ad alta flessibilità
- 1° schermo: PVC DH
- 2° schermo: a treccia di rame stagnato
- Overall jacket: Ø 6.5 mm high grade flexible PVC
- 1st shield: DH high grade PVC
- 2nd shield: dense braided tinned copper wire

CODE	LENGTH
DHG210LU1	1 mt (3,28 ft)
DHG210LU2	2 mt (6,56 ft)
DHG210LU3	3 mt (9,84 ft)
DHG210LU5	5 mt (16,40 ft)



## DHG230

### BALANCED CABLE

Ø 6.3 mm STEREO JACK PLUG – 3P MALE XLR

- Guaina esterna: Ø 6.5 mm PVC ad alta flessibilità
- 1° schermo: PVC DH
- 2° schermo: a treccia di rame stagnato
- Overall jacket: Ø 6.5 mm high grade flexible PVC
- 1st shield: DH high grade PVC
- 2nd shield: dense braided tinned copper wire

CODE	LENGTH
DHG230LU05	0,5mt (1,64 ft)
DHG230LU1	1 mt (3,28 ft)
DHG230LU2	2 mt (6,56 ft)
DHG230LU3	3 mt (9,84 ft)
DHG230LU5	5 mt (16,40 ft)
DHG230LU10	10 mt (32,81 ft)



## DHG240

### BALANCED CABLE

3P FEMALE XLR – 3P MALE XLR

- Guaina esterna: Ø 6.5 mm PVC ad alta flessibilità
- 1° schermo: PVC DH
- 2° schermo: a treccia di rame stagnato
- Overall jacket: Ø 6.5 mm high grade flexible PVC
- 1st shield: DH high grade PVC
- 2nd shield: dense braided tinned copper wire

CODE	LENGTH
DHG240LU05	0,5mt (1,64 ft)
DHG240LU1	1 mt (3,28 ft)
DHG240LU2	2 mt (6,56 ft)
DHG240LU3	3 mt (9,84 ft)
DHG240LU5	5 mt (16,40 ft)
DHG240LU6	6 mt (19,69 ft)
DHG230LU10	10 mt (32,81 ft)



## DHG505

### ADAPTER CABLE

2 x RCA - 2 x RCA

- Guaina esterna: 2 \* Ø 6.0 mm PVC ad alta flessibilità
- 1° schermo: Foglio in alluminio
- 2° schermo: a spirale di rame rosso
- Overall jacket: 2 \* Ø 6.0 mm high grade flexible PVC
- 1st shield: Aluminium foil
- 2nd shield: dense spiral red copper wire

CODE	LENGTH
DHG505LU1 8	1,8mt (5,91 ft)
DHG505LU3	3 mt (9,84 ft)
DHG505LU5	5 mt (16,40 ft)



## DHG520

### INSERT CABLE

3,5 STEREO JACK PLUG - 2 x RCA

- Guaina esterna: 2 \* Ø 4.0 mm PVC ad alta flessibilità
- 1° schermo: Foglio in alluminio
- 2° schermo: a spirale di rame rosso
- Overall jacket: 2 \* Ø 4.0 mm high grade flexible PVC
- 1st shield: Aluminium foil
- 2nd shield: dense spiral red copper wire

CODE	LENGTH
DHG520LU1 8	1,8mt (5,91 ft)
DHG520LU3	3 mt (9,84 ft)
DHG520LU5	5 mt (16,40 ft)



## DHG530

### INSERT CABLE

6,3 STEREO JACK PLUG - 2 x RCA

- Guaina esterna: 2 \* Ø 6.0 mm PVC ad alta flessibilità
- 1° schermo: Foglio in alluminio
- 2° schermo: a spirale di rame rosso
- Overall jacket: 2 \* Ø 6.0 mm high grade flexible PVC
- 1st shield: Aluminium foil
- 2nd shield: dense spiral red copper wire

CODE	LENGTH
DHG530LU1 8	1,8mt (5,91 ft)
DHG530LU3	3 mt (9,84 ft)
DHG530LU5	5 mt (16,40 ft)



## DHG535

### ADAPTER CABLE

2 x 6,3 MONO JACK PLUG - 2 x RCA

- Guaina esterna: 2 \* Ø 6.0 mm PVC ad alta flessibilità
- 1° schermo: Foglio in alluminio
- 2° schermo: a spirale di rame rosso
- Overall jacket: 2 \* Ø 6.0 mm high grade flexible PVC
- 1st shield: Aluminium foil
- 2nd shield: dense spiral red copper wire

CODE	LENGTH
DHG535LU1 8	1,8mt (5,91 ft)
DHG535LU3	3 mt (9,84 ft)
DHG535LU5	5 mt (16,40 ft)



## DHG540

### INSERT CABLE

6,3 STEREO JACK PLUG - 2 x 6,3 MONO JACK PLUG

- Guaina esterna: 2 \* Ø 6.0 mm PVC ad alta flessibilità
- 1° schermo: Foglio in alluminio
- 2° schermo: a spirale di rame rosso
- Overall jacket: 2 \* Ø 6.0 mm high grade flexible PVC
- 1st shield: Aluminium foil
- 2nd shield: dense spiral red copper wire

CODE	LENGTH
<b>DHG540LU1 8</b>	1,8mt (5,91 ft)
<b>DHG540LU3</b>	3 mt (9,84 ft)
<b>DHG540LU5</b>	5 mt (16,40 ft)



## DHG545

### INSERT CABLE

3,5 STEREO JACK PLUG - 2 x 6,3 MONO JACK PLUG

- Guaina esterna: 2 \* Ø 4.0 mm PVC ad alta flessibilità
- 1° schermo: Foglio in alluminio
- 2° schermo: a spirale di rame rosso
- Overall jacket: 2 \* Ø 4.0 mm high grade flexible PVC
- 1st shield: Aluminium foil
- 2nd shield: dense spiral red copper wire

CODE	LENGTH
<b>DHG545LU1 8</b>	1,8mt (5,91 ft)
<b>DHG545LU3</b>	3 mt (9,84 ft)
<b>DHG545LU5</b>	5 mt (16,40 ft)



## DHG550

### BALANCED CABLE

3,5 STEREO JACK PLUG - 3,5 STEREO JACK PLUG

- Guaina esterna: Ø 6.0 mm PVC ad alta flessibilità
- 1° schermo: Foglio in alluminio
- 2° schermo: a spirale di rame rosso
- Overall jacket: Ø 6.0 mm high grade flexible PVC
- 1st shield: Aluminium foil
- 2nd shield: dense spiral red copper wire

CODE	LENGTH
<b>DHG550LU1 8</b>	1,8mt (5,91 ft)
<b>DHG550LU3</b>	3 mt (9,84 ft)
<b>DHG550LU5</b>	5 mt (16,40 ft)



## DHG555

### EXTENSION BALANCED CABLE

3,5 STEREO JACK PLUG - 3,5 FEMALE STEREO JACK

- Guaina esterna: Ø 6.0 mm PVC ad alta flessibilità
- 1° schermo: Foglio in alluminio
- 2° schermo: a spirale di rame rosso
- Overall jacket: Ø 6.0 mm high grade flexible PVC
- 1st shield: Aluminium foil
- 2nd shield: dense spiral red copper wire

CODE	LENGTH
<b>DHG555LU3</b>	3 mt (9,84 ft)
<b>DHG555LU5</b>	5 mt (16,40 ft)



## DHG560

### ADAPTER BALANCED CABLE

3,5 STEREO JACK PLUG - 6,3 STEREO JACK PLUG

- Guaina esterna: Ø 6.0 mm PVC ad alta flessibilità
- 1° schermo: Foglio in alluminio
- 2° schermo: a spirale di rame rosso
- Overall jacket: Ø 6.0 mm high grade flexible PVC
- 1st shield: Aluminium foil
- 2nd shield: dense spiral red copper wire

CODE	LENGTH
<b>DHG560LU3</b>	3 mt (9,84 ft)
<b>DHG560LU5</b>	5 mt (16,40 ft)



## DHG565

### EXTENSION BALANCED CABLE

6,3 STEREO JACK PLUG - 6,3 FEMALE STEREO JACK

- Guaina esterna: Ø 6.5 mm PVC ad alta flessibilità
- 1° schermo: Foglio in alluminio
- 2° schermo: a spirale di rame rosso
- Overall jacket: Ø 6.5 mm high grade flexible PVC
- 1st shield: Aluminium foil
- 2nd shield: dense spiral red copper wire

CODE	LENGTH
<b>DHG565LU3</b>	3 mt (9,84 ft)
<b>DHG565LU5</b>	5 mt (16,40 ft)



## DHG575

### ADAPTER CABLE

6,3 MONO JACK PLUG - RCA

- Guaina esterna: Ø 6.5 mm PVC ad alta flessibilità
- 1° schermo: PVC DH
- 2° schermo: a treccia di rame rosso
- Overall jacket: Ø 6.5 mm high grade flexible PVC
- 1st shield: DH high grade PVC
- 2nd shield: dense braided red copper wire

CODE	LENGTH
<b>DHG575LU18</b>	1,8 mt (5,914 ft)
<b>DHG575LU3</b>	5 mt (9,84 ft)



## DHG580

### ADAPTER CABLE

3P FEMALE XLR - RCA

- Guaina esterna: Ø 6.5 mm PVC ad alta flessibilità
- 1° schermo: PVC DH
- 2° schermo: a treccia di rame rosso
- Overall jacket: Ø 6.5 mm high grade flexible PVC
- 1st shield: DH high grade PVC
- 2nd shield: dense braided red copper wire

CODE	LENGTH
<b>DHG580LU18</b>	1,8 mt (5,914 ft)
<b>DHG580LU3</b>	5 mt (9,84 ft)



## DHG585

### ADAPTER CABLE

3P MALE XLR - RCA

- Guaina esterna: Ø 6.5 mm PVC ad alta flessibilità
- 1° schermo: PVC DH
- 2° schermo: a treccia di rame rosso
- Overall jacket: Ø 6.5 mm high grade flexible PVC
- 1st shield: DH high grade PVC
- 2nd shield: dense braided red copper wire

CODE	LENGTH
<b>DHG585LU18</b>	1,8 mt (5,91 ft)
<b>DHG585LU3</b>	3 mt (9,84 ft)
<b>DHG585LU5</b>	5 mt (16,40 ft)



## DHG595

### STEREO CABLE

3,5 STEREO JACK PLUG - 2 x 3P MALE XLR

- Guaina esterna: 2 \* Ø 4.0 mm PVC ad alta flessibilità
- 1° schermo: Foglio in alluminio
- 2° schermo: a spirale di rame stagnato
- Overall jacket: 2 \* Ø 4.0 mm high grade flexible PVC
- 1st shield: Aluminium foil
- 2nd shield: dense spiral tinned copper wire

CODE	LENGTH
<b>DHG595LU18</b>	1,8 mt (5,91 ft)
<b>DHG595LU3</b>	3 mt (9,84 ft)
<b>DHG595LU5</b>	5 mt (16,40 ft)



ONEHERO è una nuova serie di cavi assemblati e connettori dal design unico ed esclusivo, frutto della ricerca dell'R&D di PROEL che ancora una volta, ha scelto di investire risorse nella progettazione di strumenti innovativi e professionali dedicati alle crescenti richieste del mercato. Caratteristiche distintive dei connettori sono l'ergonomicità dei manicotti, realizzati in pressofusione di zinco, la punta in ottone dorato, il guscio posteriore in nylon rinforzato, il passacavo in PVC che garantisce una eccellente protezione del cavo ed una speciale pinza interna per un semplice ed ottimale serraggio. Questa gamma di prodotti, soddisfa le maggiori tipologie di connessione in ambito professionale.

*ONEHERO is a new series of premade cables and connectors with a unique and exclusive design, the result of PROEL R & D that once again, chose to invest resources in the design of innovative and professional tools dedicated to the growing market demands. Distinctive characteristics of the connectors are the ergonomics of the sleeves, the zinc die-casting bodies, the gold-plated brass tips, the reinforced nylon rear shell, PVC sleeves which ensure an excellent protection of the cables and a special inner strain relief for a simple and optimum tightening. This range of products meets the major types of professional connection.*

# CONNECTORS

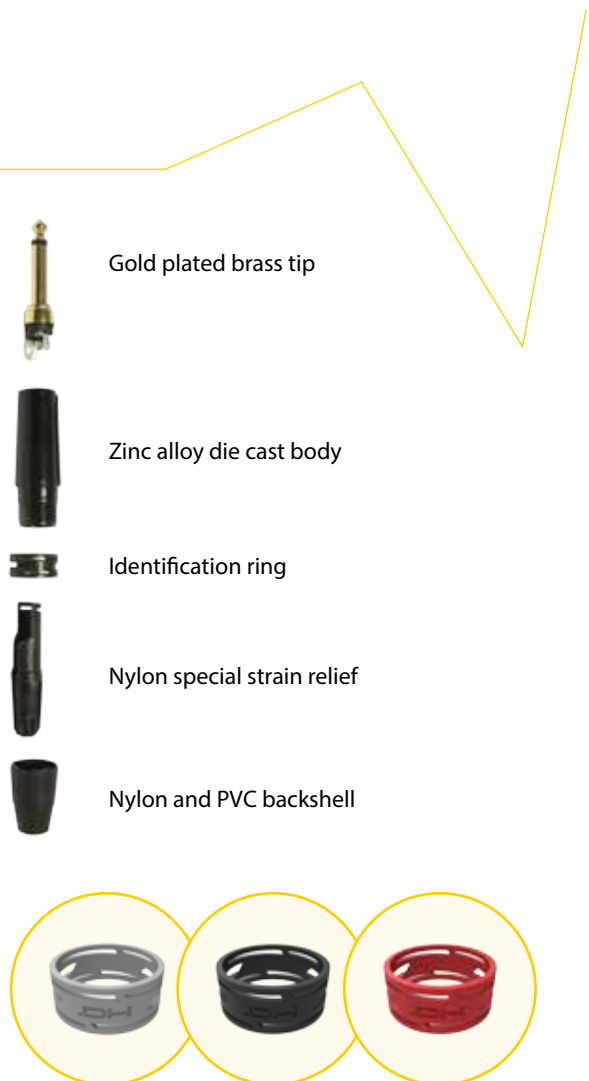



## DHJ63MBK - DHJ63MNK

• Jack Mono Professionale ONEHERO - Ø 6.3 mm - 1/4". Robusto maniccotto ergonomico realizzato in pressofusione di lega di zinco e punta in ottone dorato. Guscio posteriore in nylon rinforzato e passacavo in PVC per garantire una eccellente protezione del cavo. Speciale pinza interna per un semplice ed ottimale serraggio. Disponibile in nero opaco (DHJ63MBK) e nickel (DHJ63MNK). Fornito con anelli colorati: grigio, rosso e nero.

• ONEHERO Professional Ø 6.3 mm Mono jack plug, Featuring ergonomic and heavy duty body made by zinc alloy die-casting and golden plate brass tip. Reinforced nylon rear shell and PVC sleeve to provide excellent cable protection. Special inner strain relief for a simple and optimum tightening. Available in matt black (DHJ63MBK) and nickel (DHJ63MNK). Supplied with colored rings: grey, red and black.



## DHJ63SBK - DHJ63SNK

• Jack Stereo Professionale ONEHERO - Ø 6.3 mm - 1/4", con le stesse caratteristiche del connettore Mono. Disponibile in nero opaco (DHJ63SBK) e nickel (DHJ63SNK). Fornito con anelli colorati: grigio, rosso e nero.

• ONEHERO Professional Ø 6.3 mm Stereo jack plug, featuring the same characteristics of the Mono connector. Available in matt black (DHJ63SBK) and nickel (DHJ63SNK). Supplied with colored rings: grey, red and black.



## DHJ63MABK - DHJ63MANK

• Jack Mono Professionale ONEHERO - Ø 6.3 mm - 1/4" ad angolo 90° con le stesse caratteristiche del connettore dritto. Disponibile in nero opaco (DHJ63MABK) e nickel (DHJ63MANK). Fornito con anelli colorati: grigio, rosso e nero.

• ONEHERO Professional Ø 6.3 mm Mono 90° angle jack plug, featuring the same characteristics of the straight connector. Available in matt black (DHJ63MABK) and nickel (DHJ63MANK). Supplied with colored rings: grey, red and black.



## DHJ35SBK - DHJ35SNK

• Jack Stereo Professionale ONEHERO - Ø 3.5 mm - 1/8". Robusto maniccotto ergonomico realizzato in pressofusione di lega di zinco. La punta in ottone dorato, ha uno speciale anello distanziale che permette l'utilizzo del connettore con smartphone e tablet muniti di custodia. Passacavo posteriore in PVC per garantire una eccellente protezione del cavo. Speciale pinza interna per un semplice ed ottimale serraggio. Disponibile in nero opaco (DHJ35SBK) e nickel (DHJ35SNK).

• ONEHERO Professional Ø 3.5 mm Stereo jack plug, Featuring ergonomic and heavy duty body made by zinc alloy die-casting. The golden plate brass tip features a special spacer ring to allow the use of the connector with smartphones and tablets bearing dedicated housing. PVC back sleeve to provide excellent cable protection. Special inner strain relief for a simple and optimum tightening. Available in matt black (DHJ35SBK) and nickel (DHJ35SNK).



## DHFX3PBK - DHFX3PNK

• Connettore Professionale XLR 3 poli femmina volante ONEHERO. Fornito di un innovativo pulsante di rilascio dalla connessione. Robusto manicotto ergonomico realizzato in pressofusione di lega di zinco e speciali contatti dorati per incrementare la conduttività. Guscio posteriore in nylon rinforzato e passacavo in PVC per garantire una eccellente protezione del cavo. Speciale pinza interna per un semplice ed ottimale serraggio, adatta a ricevere cavi da 3 a 7 mm di diametro. Disponibile in nero opaco (DHFX3PBK) e nickel (DHFX3PNK). Fornito con anelli colorati: grigio, rosso e nero.

• ONEHERO 3 pole female Professional XLR cable mount connector. Supplied with an improved button for latch lock. Featuring ergonomic and heavy duty body made by zinc alloy die-casting and special gold plated contacts that increase the conductivity. Reinforced nylon rear shell and PVC sleeve to provide excellent cable protection. Special inner strain relief for a simple and optimum tightening that allows to receive cables from 3 to 7 mm diameter. Available in matt black (DHFX3PBK) and nickel (DHFX3PNK). Supplied with colored rings: grey, red and black.



## DHMX3PBK - DHMX3PNK

• Connettore Professionale XLR 3 poli maschio volante ONEHERO. Dotato di robusto manicotto ergonomico realizzato in pressofusione di lega di zinco e speciali contatti di dimensioni maggiorate per incrementare la conduttività ed evitare il movimento durante la connessione. Guscio posteriore in nylon rinforzato e passacavo in PVC per garantire una eccellente protezione del cavo. Speciale pinza interna per un semplice ed ottimale serraggio, adatta a ricevere cavi da 3 a 7 mm di diametro. Disponibile in nero opaco (DHMX3PBK) e nickel (DHMX3PNK). Fornito con anelli colorati: grigio, rosso e nero.

• ONEHERO 3 pole Professional XLR cable mount connector. Featuring ergonomic and heavy duty body made by zinc alloy die-casting and special gold plated improved contacts that increase the conductivity and avoid moving. Reinforced nylon rear shell and PVC sleeve to provide excellent cable protection. Special inner strain relief for a simple and optimum tightening that allows to receive cables from 3 to 7 mm diameter. Available in matt black (DHMX3PBK) and nickel (DHMX3PNK). Supplied with colored rings: grey, red and black.



## DHRCAMBB – DHRCAMBR

• Connettore Professionale RCA maschio volante ONEHERO. Dotato di robusto manicotto ergonomico realizzato in pressofusione di lega di zinco e speciali contatti per incrementare la conduttività ed evitare il movimento durante la connessione. Passacavo in PVC per garantire una eccellente protezione del cavo. Disponibile in nero opaco con passacavo nero (DHRCAMBB) e passacavo rosso (DHRCAMBR).

• ONEHERO Professional male RCA cable mount connector. Featuring ergonomic and heavy duty body made by zinc alloy die-casting and special gold plated improved contacts that increase the conductivity and avoid moving. PVC sleeve to provide excellent cable protection. Available in matt black with black sleeve (DHRCAMBB) or red sleeve (DHRCAMBR).



## DHRCAMNB – DHRCAMNR

• Connettore Professionale RCA maschio volante ONEHERO, con le stesse caratteristiche del connettore nero. Disponibile nel colore nickel con passacavo nero (DHRCAMNB) e passacavo rosso (DHRCAMNR).

• ONEHERO Professional male RCA, featuring the same characteristics of the black connector Available in nickel plated body with black sleeve (DHRCAMNB) or red sleeve (DHRCAMNR).



• Linea completa di adattatori professionali per tutte le diverse soluzioni di interconnessione. Realizzati con corpo interamente in metallo e ricoperti in materiale plastico ad alta resistenza, con terminazioni anticorrosione placcate in oro 24k. Colore nero. Confezione standard: 4 pezzi

• Complete line of professional adapters for different interconnecting solutions. They are constructed with solid metal body with external high grade plastic compound covering and 24k Gold plated corrosion free connections. Black color. Master pack: 4 pcs.

### DHMA290

Ø 6.3 mm MONO JACK  
3P FEMALE XLR



### DHMA295

Ø 6.3 MM STEREO JACK  
3P FEMALE XLR



### DHMA300

Ø 6.3 MM MONO JACK  
3P MALE XLR



### DHMA305

Ø 6.3 MM STEREO JACK  
3P MALE XLR



### DHMA320

Ø 6.3 MM MONO JACK SOCKET  
3P MALE XLR



### DHMA500

RCA FEMALE  
3P MALE XLR



### DHMA615

3P XLR MALE  
Ø 6.3 mm STEREO JACK SOCKET



### DHMA625

3P FEMALE XLR  
Ø 6.3 mm STEREO JACK SOCKET



### DHPA108

Ø 3.5 mm STEREO JACK SOCKET  
Ø 3.5 mm STEREO JACK SOCKET



### DHPA122A

Ø 3.5 MM STEREO JACK  
Ø 3.5 mm STEREO JACK SOCKET



### DHPA120

Ø 3.5 MM STEREO JACK  
Ø 6.3 mm STEREO JACK SOCKET



### DHPA158

Ø 6.3 MM MONO JACK  
Ø 3.5 mm STEREO JACK SOCKET



### DHPA140

Ø 3.5 MM STEREO JACK  
2 X Ø 3.5 mm STEREO JACK SOCKET



### DHPA170

Ø 6.3 MM STEREO JACK  
2 X Ø 3.5 mm STEREO JACK SOCKET



### DHPA165

Ø 6.3 MM STEREO JACK  
Ø 3.5 mm STEREO JACK SOCKET



### DHPA190

Ø 6.3 MM MONO JACK  
RCA FEMALE



### DHPA180

RCA MALE  
Ø 6.3 mm MONO JACK SOCKET



### DHPA250

Ø 6.3 MM STEREO JACK  
2 X RCA FEMALE



### DHPA210

RCA SOCKET  
RCA SOCKET





# HARD CASES

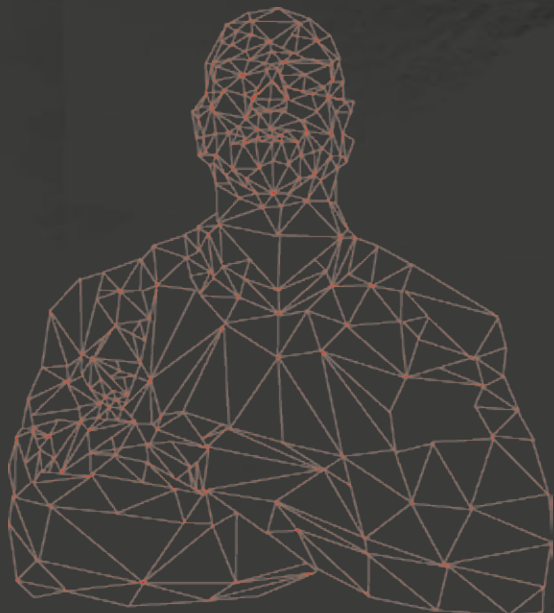

La serie di custodie DHCASES, costruita con elevati standard qualitativi, è stata progettata e realizzata per essere utilizzata in tutti i tipi di applicazioni per trasportare e proteggere apparecchiature sensibili anche in condizioni estreme e con alte variazioni di temperatura - tutti i prodotti sono stati testati da  $-40^{\circ}\text{C}$  fino a  $+80^{\circ}\text{C}$ .

Tutti i prodotti sono realizzati mediante stampaggio ad iniezione, utilizzando compound di Polipropilene modificato equilibrato con resine ad alte prestazioni, in grado di fornire una protezione totale contro polvere, acqua, urti e alla corrosione degli agenti chimici. La miscelazione dei materiali di costruzione permette di ottenere custodie più leggere ma molto più robuste dei cases standard. Tutti i prodotti sono inoltre dotati di una valvola per la regolazione della pressione interna e predisposti per la chiusura con lucchetto.

*The DHCASE series, built with high quality standards, have been designed and created to be used for all sort of applications to transport and protect sensitive equipment even in extreme conditions and temperature changes - all products are tested from  $-40^{\circ}\text{C}$  up to  $+80^{\circ}\text{C}$ .*

*All the cases are constructed of injection-molded PP compound material balanced with high performance resins and provide total protection against dust, water, impacts and corrosion of chemical agents. The mixing of the construction materials allows to produce cases which are lighter in weight and strong in robustness. They are also equipped with a valve for the internal pressure regulation and geared for padlock closure.*

## APPROVALS TEST

- ATA 300
- IP67
- STANAG 4280
- DS 81-41
- DROP
- IMPACT
- WATERTIGHT INTEGRITY
- UV COLOR AND MATERIAL PROTECTION





## DHCASE304

Modified PP injection case. External dimensions: W 335 mm x D 289 mm x H 155 mm  
/ Internal dimensions: W 304 mm x D 231 mm x H 137 (106 + 31) mm. Black color.



## DHCASE380

Modified PP injection case. External dimensions: W 405 mm x D 330 mm x H 170 mm  
/ Internal dimensions: W 380 mm x D 266 mm x H 152 (107 + 45) mm. Black color.



## **DHCASE450**

Modified PP injection case. External dimensions: W 478 mm x D 390 mm x H 194 mm  
/ Internal dimensions: W 450 mm x D 323 mm x H 175 (129 + 46) mm. Black color.



## **DHCASE492**

Modified PP injection case. External dimensions: W 543 mm x D 419 mm x H 218 mm  
/ Internal dimensions: W 482 mm x D 358 mm x H 198 (152 + 46) mm. Black color.







### **DHCASE510W**

*Wheeled modified PP injection case, featuring practical retractile aluminium handle. External dimensions: W 549 mm x D 346 mm x H 236 mm / Internal dimensions: W 513 mm x D 288 mm x H 200 (152 + 48) mm. Black color.*

### **DHCASE482W**

*Wheeled modified PP injection case, featuring practical retractile aluminium handle. External dimensions: W 546 mm x D 423 mm x H 250 mm / Internal dimensions: W 482 mm x D 358 mm x H 218 (172 + 46) mm. Black color.*



### **DHCASE555W**

*Wheeled modified PP injection case, featuring practical retractile aluminium handle. External dimensions: W 620 mm x D 525 mm x H 280 mm / Internal dimensions: W 555 mm x D 459 mm x H 256 (211 + 45) mm. Black color.*

# ARMOR BAGS

Proel presenta la nuova serie di borse professionali per chitarra ARMOR, studiate per offrire la massima protezione e per soddisfare tutte le esigenze dei musicisti. Tutte le borse sono realizzate in robusto Nylon 1680D "waterproof" di alta qualità con cuciture rinforzate dal design unico. Provviste di imbottitura in DHFOAM® da 35mm complessivi e rivestimento interno in morbido velluto di colore grigio. Sono inoltre dotate di poggia manico con strap in velcro e di inserti regolabili sulla base per un ottimale posizionamento dello strumento.

*Proel introduces the new ARMOR series of professional guitar bags, designed to offer maximum protection and to meet all the needs of musicians. All bags are made of durable and high quality 1680D Nylon "waterproof" with unique design reinforced seams. Provided with DHFOAM® 35mm padding and a total inner lining made of soft gray velvet. They are also equipped with Velcro fixed neck rest and adjustable padded insert on the base for an optimal positioning of the instrument.*



- Morbido rivestimento interno in velluto con inserti cuciti e rinforzati per meccaniche e paletta
- Soft inner velvet lining with sewn-in additional protection for bridge and mechanics

## SOFT BAGS

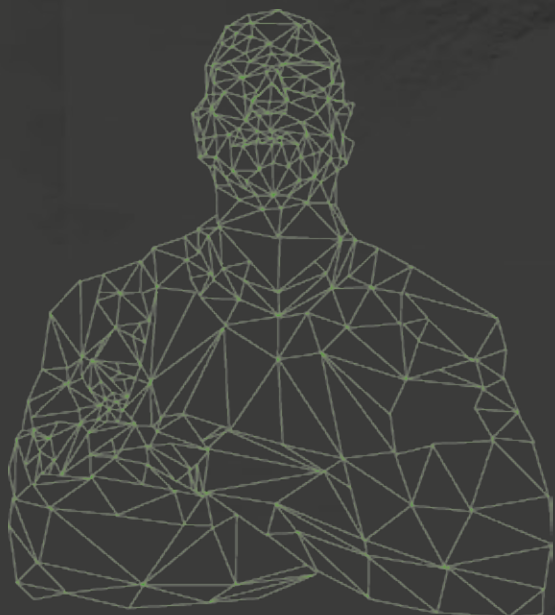



- Ampie tasche frontali con numerosi scomparti per libri di musica, tablet, cavi etc.
- *Large front pockets with several compartments for music books, tablets, cables etc.*



- Maniglia dal design unico
- *Unique design handle*



- Confortevole maniglia imbottita
- *Comfortable padded handle*



- Tracolle posteriori regolabili imbottite a scomparsa, con ganci in metallo
- *Adjustable padded and retractable rear straps, with metal hooks*



- Chiusure rinforzate con Zip DH ottenute in pressofusione
- *Reinforced die cast aluminum DH zip pulls*





## DHZAGB *New*

- Borsa imbottita per chitarra Acustica. Disponibile nel colore nero.
- *Padded Acoustic guitar bag. Available in black.*



## DHZCGB *New*

- Borsa imbottita per chitarra Classica. Disponibile nel colore nero.
- *Padded Classic guitar bag. Available in black.*





**DHZEGB** *New*

- Borsa imbottita per chitarra Elettrica. Disponibile nel colore nero.
- *Padded Electric guitar bag. Available in black.*



**DHZEBB** *New*

- Borsa imbottita per Basso elettrico. Disponibile nel colore nero.
- *Padded electric Bass bag. Available in black.*





La serie di borse per chitarra DH SUN è stata pensata per studenti e musicisti che cercano qualità e praticità. Tutte le borse sono realizzate in Nylon 420D di alta qualità, con cuciture rinforzate e imbottitura interna in DHFOAM®. Dotate di un'ampia tasca anteriore porta spartiti provvista di custodia imbottita fissa per laptop (non inclusa sulla serie 100) e tasca addizionale arrotondata provvista di stringa fermacavi in Velcro e scomparti per accessori (non inclusa sulla serie 100).

Caratteristiche:

- Tracolle posteriori regolabili
- Supporto lombare imbottito (non incluso sulla serie 100)
- Confortevole maniglia imbottita
- Bande catarifrangenti di sicurezza
- Rivestimento interno in Nylon 190D con inserti cuciti e rinforzati per meccaniche e ponte
- Chiusure rinforzate con Zip DH ottenute in pressofusione
- Imbottitura da 20 mm in DHFOAM® (tranne serie 100)
- Imbottitura da 5 mm in DHFOAM® (serie 100)

*The DH SUN series guitar bags was studied for students and musicians that are looking for quality and practicality. All bags are made from high quality 420D. Rugged polyester material with reinforced seams and DHFOAM® padding. Large front pocket for music books provided with padded laptop protection pouch (not included on the 100 series). Additional round shaped front accessory pocket with Velcro tie for cable and internal organizer pouches. (not included on the 100 series).*

Key features:

- Adjustable rucksack straps.
- Ergonomic mesh lumbar support (not included on the 100 series)
- Comfortable foam mesh handle
- Reflective safety strips.
- Soft Nylon 190D non-scratch interior lining with sewn-in additional protection for bridge and mechanics.
- Reinforced zips with moulded DH zip pulls.
- 20 mm DHFOAM® padding (not on 100 series)
- 5 mm DHFOAM® padding (100 series)

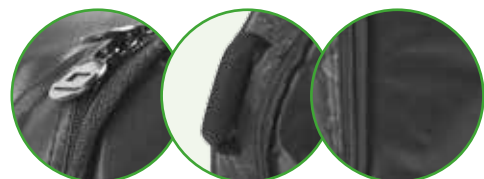

# SOFT BAGS

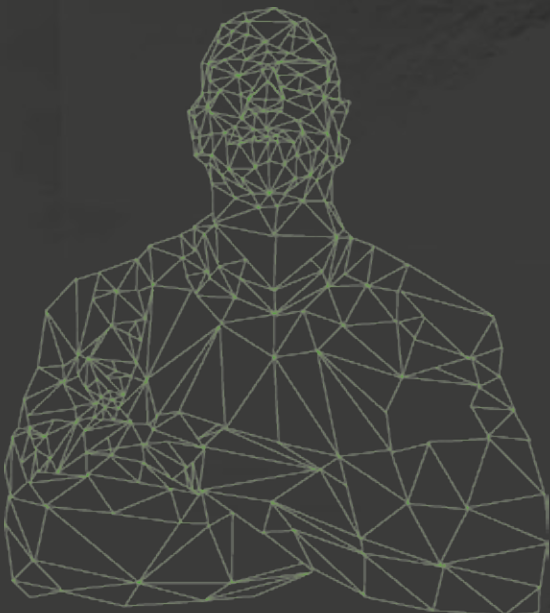





## DHSCG100

- Borsa imbottita per chitarra Classica in nylon 420D antistrappo. Disponibile nel colore nero.
- Padded 420D rip-proof nylon Classic guitar bag. Available in black.

## DHSAG100

- Borsa imbottita per chitarra Acustica in nylon 420D antistrappo. Disponibile nel colore nero.
- Padded 420D rip-proof nylon Acoustic guitar bag. Available in black.



## DHSEG100

- Borsa imbottita per chitarra Elettrica in nylon 420D antistrappo. Disponibile nel colore nero.
- Padded 420D rip-proof nylon Electric guitar bag. Available in black.

## DHSBG100

- Borsa imbottita per Basso elettrico in nylon 420D antistrappo. Disponibile nel colore nero.
- Padded 420D rip-proof nylon electric Bass bag. Available in black.







## DHSCG

- Borsa imbottita per chitarra Classica in nylon 420D antistrappo. Disponibile nel colore nero.
- *Padded 420D rip-proof nylon Classic guitar bag. Available in black.*



## DHSAG

- Borsa imbottita per chitarra Acustica in nylon 420D antistrappo. Disponibile nel colore nero.
- *Padded 420D rip-proof nylon Acoustic guitar bag. Available in black.*



## DHSEG

- Borsa imbottita per chitarra Elettrica in nylon 420D antistrappo. Disponibile nel colore nero.
- *Padded 420D rip-proof nylon Electric guitar bag. Available in black.*



## DHSBG

- Borsa imbottita per Basso elettrico in nylon 420D antistrappo. Disponibile nel colore nero.
- *Padded 420D rip-proof nylon electric Bass bag. Available in black.*



Borse professionali per tastiera realizzate in robusto nylon 600D "waterproof" con imbottitura in DHFOAM da 30 mm e 3 mm di imbottitura extra ricoperta in morbido tessuto. Provviste di tracolle imbottite sganciabili e regolabili con ganci in metallo, di confortevoli maniglie imbottite e di 3 ampie tasche frontali A4 per libri di musica ed accessori. All'interno hanno due morbide cinghie per fissare lo strumento ed inoltre sono dotate di due resistenti ruote per un pratico e confortevole trasporto.

# SOFT BAGS

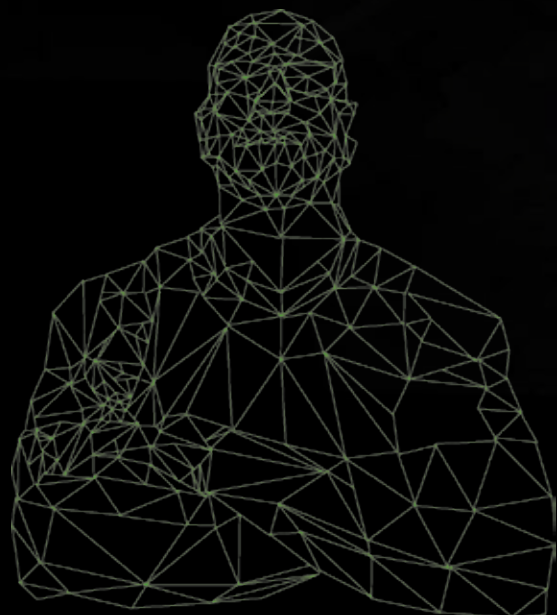

*Professional keyboard bags made of 600D rugged and "waterproof" nylon with 30mm DHFOAM® padding and 3mm extra inner soft lining. Featuring strong adjustable and detachable padded strap with metal hardware, comfortable foam mesh carrying handles and three A4 DIN size pockets for books and accessories. They are also equipped with inner padded straps to hold the instrument and two pairs of strong wheels for a practical and comfortable carriage.*



## DHMKEY76

• Borsa professionale per tastiera 76 tasti, realizzata in robusto nylon 600D "waterproof" con imbottitura in DHFOAM da 30 mm e 3 mm di imbottitura extra ricoperta in morbido tessuto. Dotata di due resistenti ruote per un pratico e confortevole trasporto. Dimensioni: 1300 (larghezza) x 450 (profondità) x 170 (altezza) mm. Imbottitura 20 mm. Colore nero.

• Professional 76 keys keyboard bag made of 600D rugged and "waterproof" nylon with 30mm DHFOAM® padding and 3mm extra inner soft lining. Featuring two pairs of strong wheels for a practical and comfortable carriage. Inner dimensions: 1300 (width) x 450 (depth) x 170 (height) mm. 20mm soft foam padding. Black colour.



## DHMKEY76SL

• Borsa professionale per tastiera 76 tasti, realizzata in robusto nylon 600D "waterproof" con imbottitura in DHFOAM da 30 mm e 3 mm di imbottitura extra ricoperta in morbido tessuto. Dotata di due resistenti ruote per un pratico e confortevole trasporto. Dimensioni: 1250 (larghezza) x 370 (profondità) x 150 (altezza) mm. Imbottitura 20 mm. Colore nero.

• Professional 76 keys keyboard bag made of 600D rugged and "waterproof" nylon with 30mm DHFOAM® padding and 3mm extra inner soft lining. Featuring two pairs of strong wheels for a practical and comfortable carriage. Inner dimensions: 1250 (width) x 370 (depth) x 150 (height) mm. 20mm soft foam padding. Black colour.

## DHMKEY61

• Borsa professionale per tastiera 61 tasti, realizzata in robusto nylon 600D "waterproof" con imbottitura in DHFOAM da 30 mm e 3 mm di imbottitura extra ricoperta in morbido tessuto. Dotata di due resistenti ruote per un pratico e confortevole trasporto. Dimensioni: 1090 (larghezza) x 445 (profondità) x 165 (altezza) mm. Imbottitura 20 mm. Colore nero.

• Professional 61 keys keyboard bag made of 600D rugged and "waterproof" nylon with 30mm DHFOAM® padding and 3mm extra inner soft lining. Featuring two pairs of strong wheels for a practical and comfortable carriage. Inner dimension: 1090 (width) x 445 (depth) x 165 (height) mm. 20mm soft foam padding. Black colour.





## DHMKEY88SL

- Borsa professionale per tastiera 88 tasti, realizzata in robusto nylon 600D "waterproof" con imbottitura in DHFOAM da 30 mm e 3 mm di imbottitura extra ricoperta in morbido tessuto. Dotata di due resistenti ruote per un pratico e confortevole trasporto. Dimensioni: 1360 (larghezza) x 430 (profondità) x 150 (altezza) mm. Imbottitura 20 mm. Colore nero.

- Professional 88 keys keyboard bag made of 600D rugged and "waterproof" nylon with 30mm DHFOAM® padding and 3mm extra inner soft lining. Featuring two pairs of strong wheels for a practical and comfortable carriage. Inner dimensions: 1360 (width) x 430 (depth) x 150 (height) mm. 20mm soft foam padding. Black colour.

## DHMKEY88

- Borsa professionale per tastiera 88 tasti, realizzata in robusto nylon 600D "waterproof" con imbottitura in DHFOAM da 30 mm e 3 mm di imbottitura extra ricoperta in morbido tessuto. Dotata di due resistenti ruote per un pratico e confortevole trasporto. Dimensioni: 1460 (larghezza) x 457 (profondità) x 160 (altezza) mm. Imbottitura 20 mm. Colore nero.

- Professional 88 keys keyboard bag made of 600D rugged and "waterproof" nylon with 30mm DHFOAM® padding and 3mm extra inner soft lining. Featuring two pairs of strong wheels for a practical and comfortable carriage. Inner dimensions: 1460 (width) x 457 (depth) x 160 (height) mm. 20mm soft foam padding. Black colour.





# ALPHABETICAL INDEX

CODE	PAGE	CODE	PAGE	CODE	PAGE
DHCASE304	29	DHKS40	8	DHRCAMBR	25
DHCASE380	29	DHKS50	8	DHRCAMNB	25
DHCASE450	30	DHKS52	9	DHRCAMNR	25
DHCASE482W	31	DHMA290	26	DHS100	15
DHCASE492	30	DHMA295	26	DHS120	15
DHCASE510W	31	DHMA300	26	DHS140	15
DHCASE555W	31	DHMA305	26	DHS200	15
DHFX3PBK	25	DHMA320	26	DHS210	15
DHFX3PNK	25	DHMA500	26	DHS220	15
DHG100	19	DHMA615	26	DHS230	16
DHG120	19	DHMA625	26	DHS240	16
DHG140	19	DHMKEY61	40	DHS505	16
DHG200	19	DHMKEY76	40	DHS520	16
DHG210	19	DHMKEY76SL	40	DHS530	16
DHG220	19	DHMKEY88	41	DHS535	16
DHG230	20	DHMKEY88SL	41	DHS540	17
DHG240	20	DHMS75	13	DHS545	17
DHG505	20	DHMSS10	12	DHS550	17
DHG520	20	DHMSS30	12	DHS560	17
DHG530	20	DHMX3PBK	25	DHS595	17
DHG535	20	DHMX3PNK	25	DHS600	17
DHG540	21	DHPA108	27	DHSAG	38
DHG545	21	DHPA120	27	DHSAG100	37
DHG550	21	DHPA122A	27	DHSBG	38
DHG555	21	DHPA140	27	DHSBG100	37
DHG560	21	DHPA158	27	DHSCG	38
DHG565	21	DHPA165	27	DHSCG100	37
DHG575	22	DHPA170	27	DHSEG	38
DHG580	22	DHPA180	27	DHSEG100	37
DHG585	22	DHPA190	27	DHSS20	11
DHG595	22	DHPA210	27	DHSS30	11
DHJ35SBK	24	DHPA250	27	DHSS40	10
DHJ35SNK	24	DHPGS10	13	DHSS50KIT	10
DHJ63MABK	24	DHPMS10	7	DHSS60	10
DHJ63MANK	24	DHPMS30	7	DHZAGB	34
DHJ63MBK	24	DHPMS40	5	DHZCGB	34
DHJ63MNK	24	DHPMS50	5	DHZEBB	35
DHJ63SBK	24	DHPMS55	6	DHZEGB	35
DHJ63SNK	24	DHPMS60	6		
DHKS10BK	9	DHPMS70	7		
DHKS10SL	9	DHRCAMBB	25		

DHCAT17IE

• Tutte le specifiche possono essere variate senza alcuna notifica • Design and specifications subject to change without any notice

• È vietata la riproduzione fotostatica e fotografica del presente catalogo, o di parti di esso, in mancanza di espressa autorizzazione da parte di Proel S.p.a.  
 • The photostatic and photographic reproduction of this catalogue, in whole or in part, is strictly prohibited without the prior written consent of Proel S.p.A.



The logo consists of the letters 'DH' in a bold, metallic, sans-serif font. The 'D' has a small red rectangular element at its base. The 'H' is also in a metallic style with a slight shadow effect.

**DH**  
is a brand of

PROEL SPA  
(Worldwide Headquarters)  
Via alla Ruenia, 37/43  
64027 Sant'Omero (TE) - ITALY  
Tel. +39 0861 81241  
Fax +39 0861 887862  
P.I. 00778590679  
N.Reg.AEE IT 08020000002762

